

Name	VS44_0190 376x587/44 Keira L		
Zeichnung/Drawing	3D		
Maßstab/Scale	1:40	Profil/Profile	4.4x13.5
		Druck auf/ Print on	A3
		Datum/Date	01.07.2024

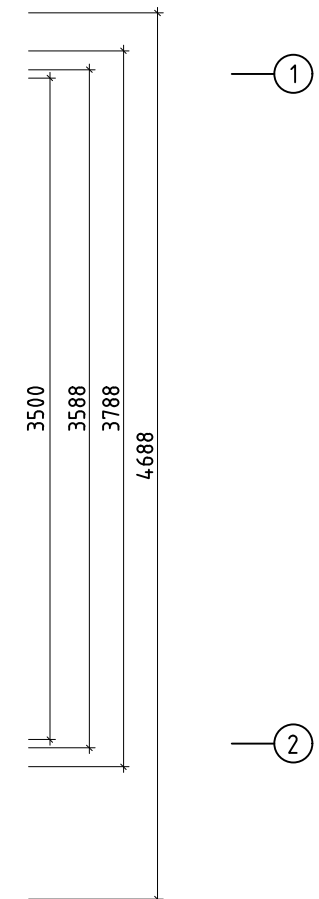
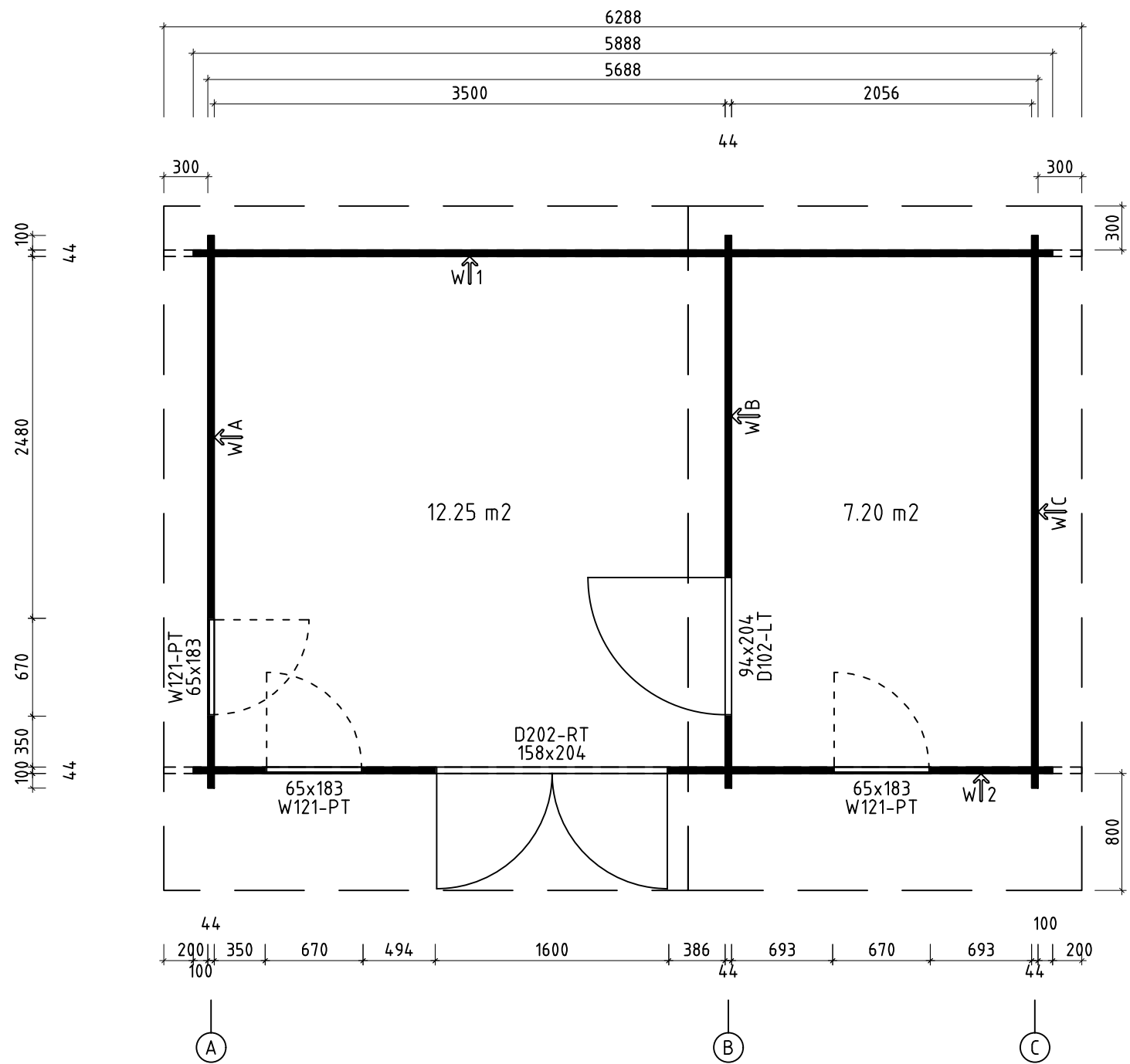

Q3 – Qualitätsklasse für Fenster und Türen/  
Quality class for windows and doors

\* Fenster und Türen sind ohne Sprossen  
Windows and doors are without muntins

Name	VS44_0190 376x587/44 Keira L		
Zeichnung/Drawing	Grundplan; Plan		
Maßstab/Scale	1:40	Profil/Profile	4.4x13.5
Druck auf/ Print on	A3	Datum/Date	01.07.2024

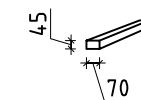
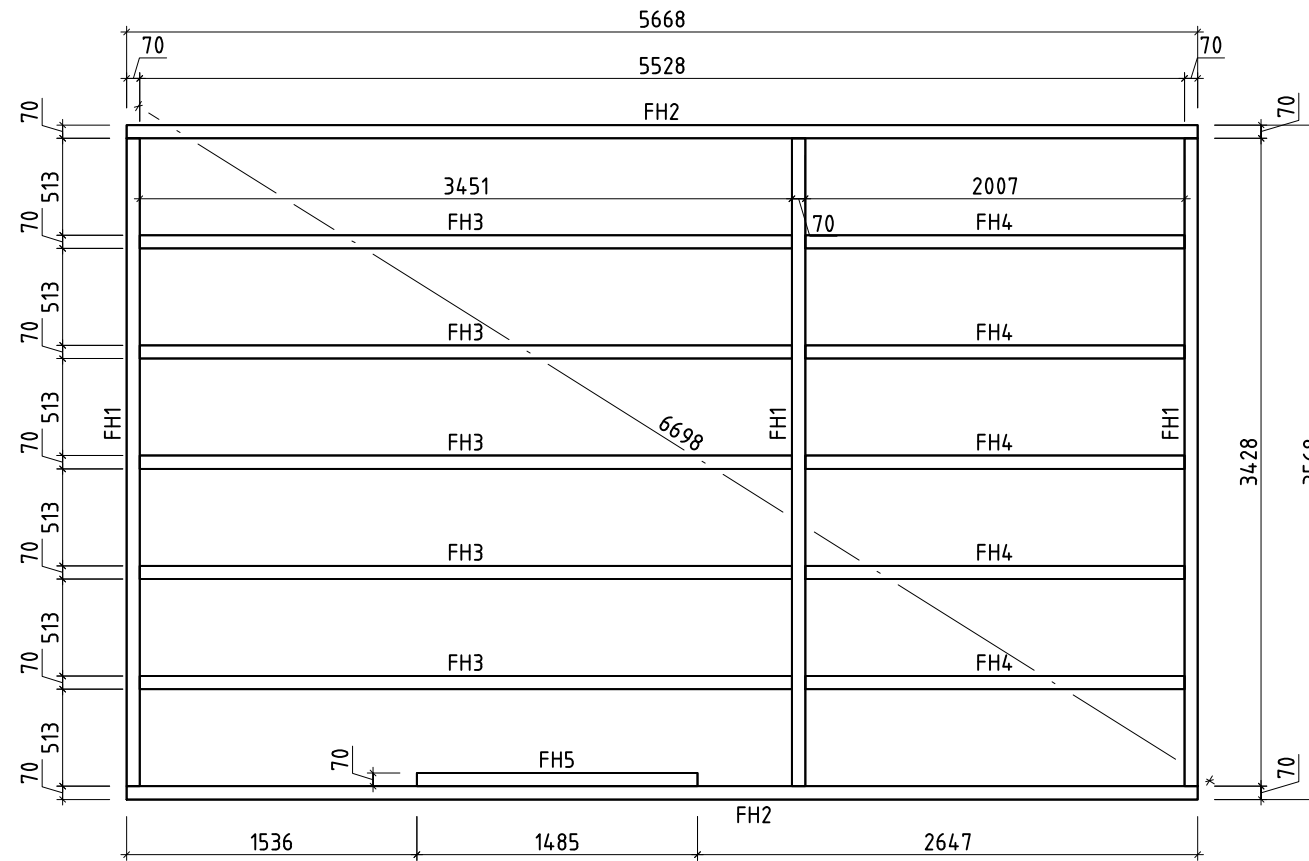

Name	VS44_0190 376x587/44 Keira L		
Zeichnung/Drawing	Lagerholzplan; Foundation beams		
Maßstab/Scale	1:40	Profil/Profile	4.4x13.5
Druck auf/Print on	A3	Datum/Date	01.07.2024

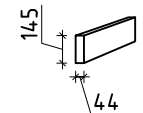
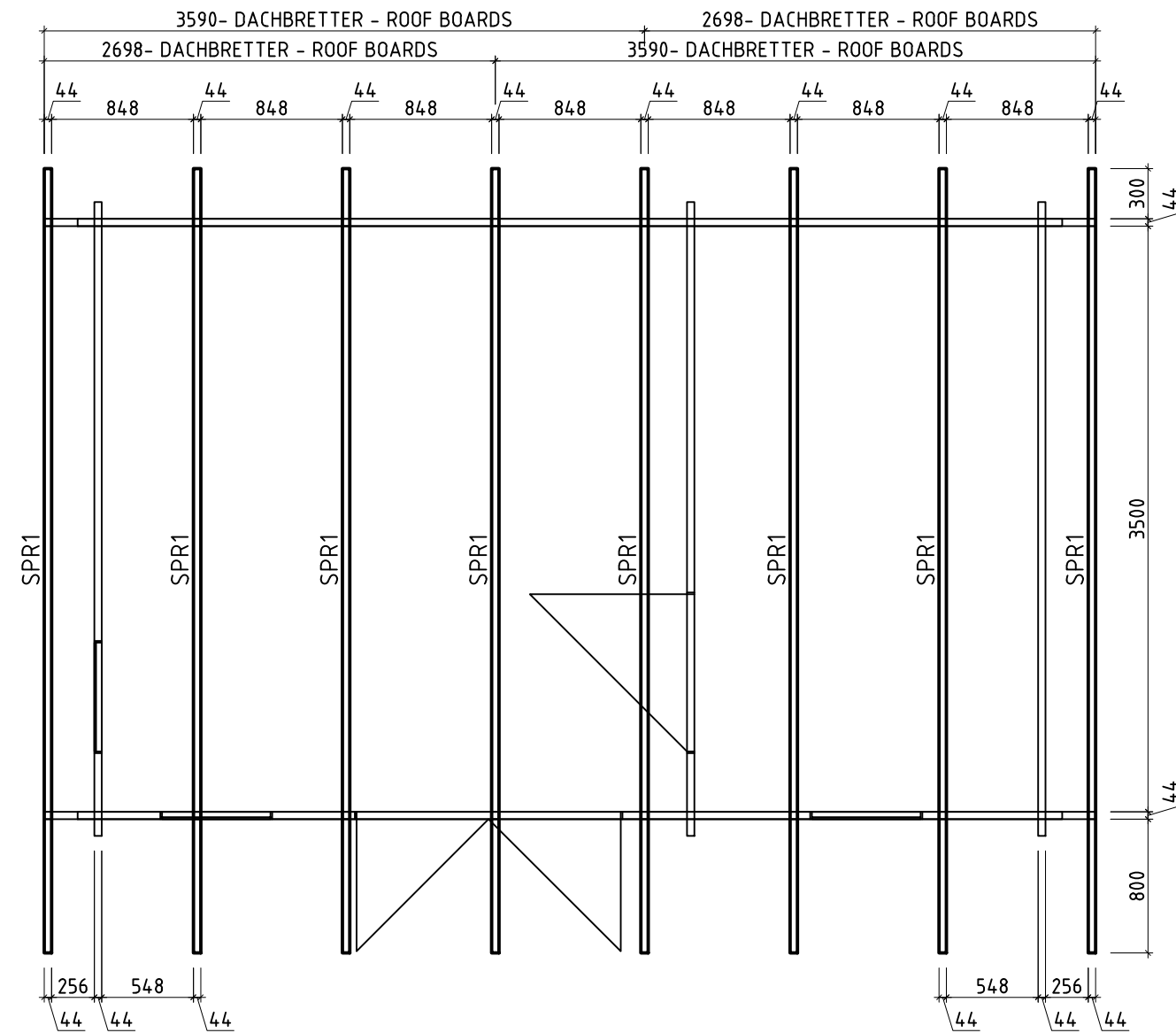

Name	VS44_0190 376x587/44 Keira L		
Zeichnung/Drawing	Sparren; Rafters		
Maßstab/Scale	1:40	Profil/Profile	4.4x13.5
		Druck auf/ Print on	A3
		Datum/Date	01.07.2024

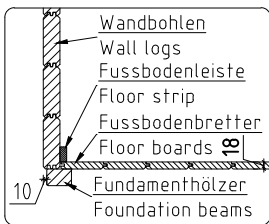
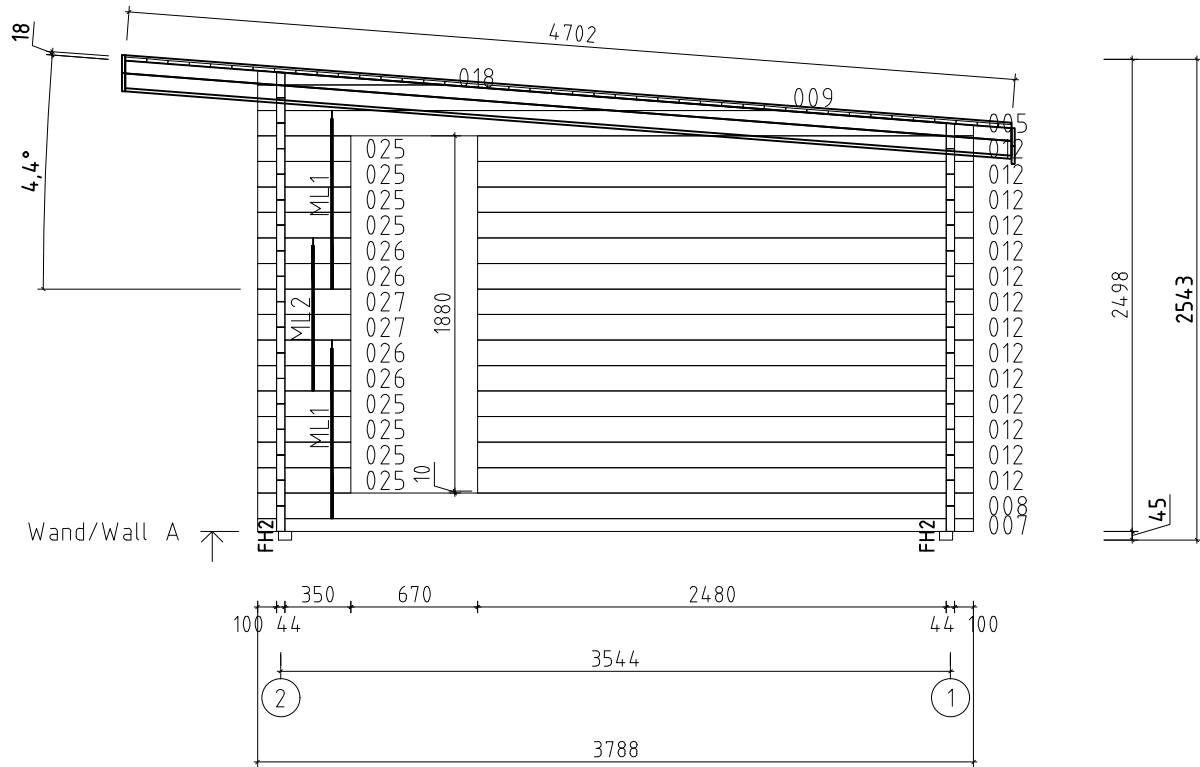
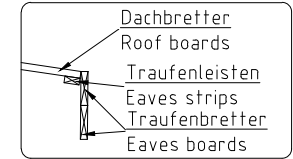
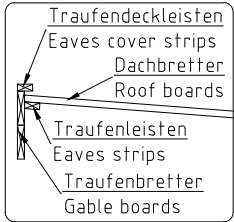

Name		VS44_0190 376x587/44 Keira L	
Zeichnung/Drawing		WAND/WALL A	
Maßstab/Scale	1:40	Profil/Profile	4.4x13.5
Druck auf/Print on	A4	Datum/Date	01.07.2024





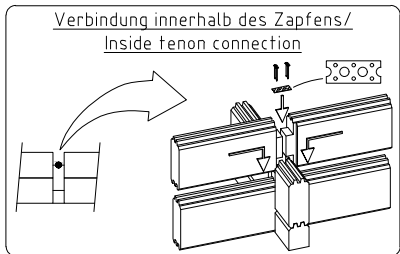
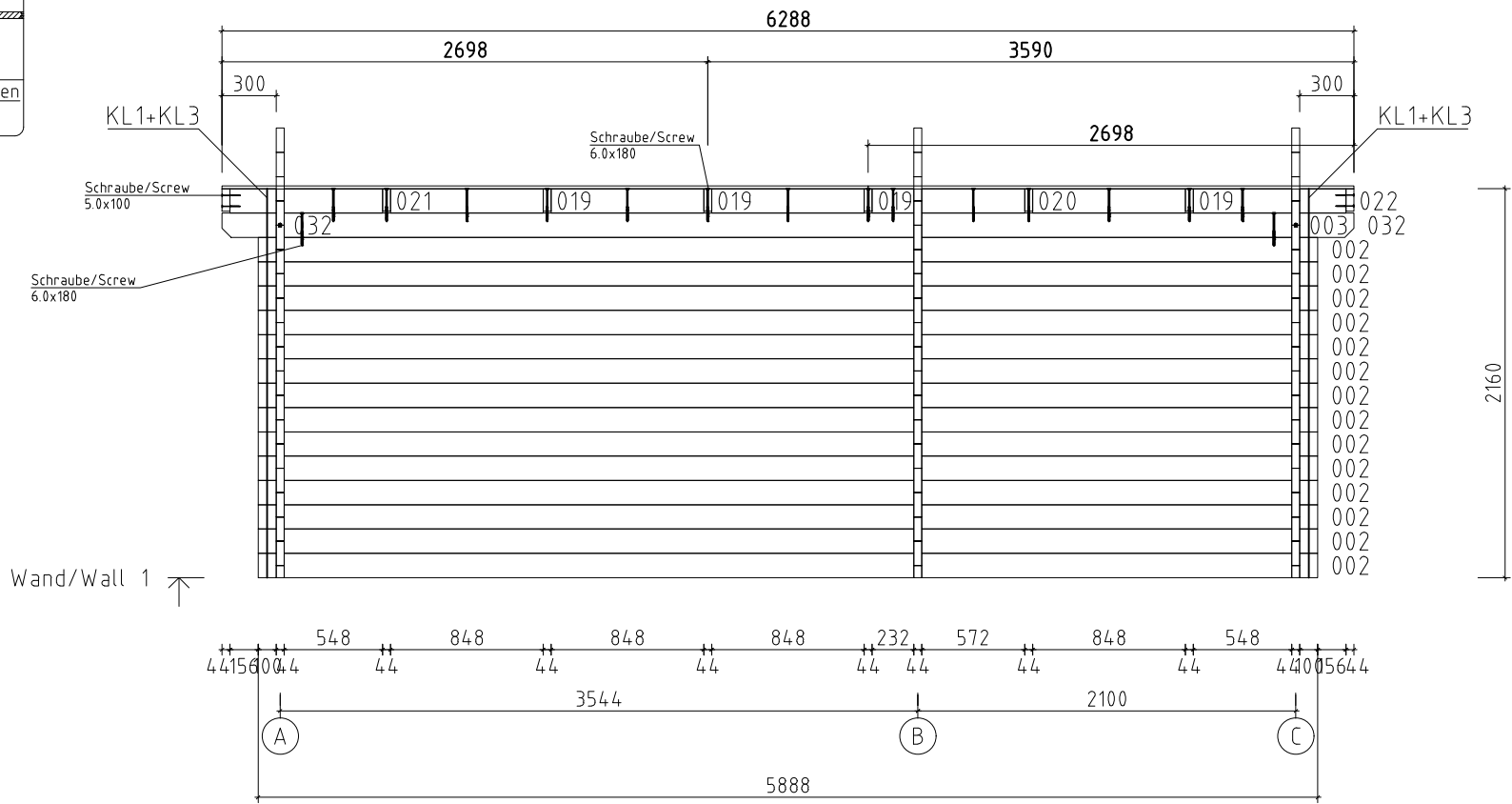

- Giebeldeckleisten
- Gable cover boards
- Dachbretter
- Roof boards
- Giebelbretter
- Gable boards
- Pfetten/Wandbohlen
- Purlins/Wall log





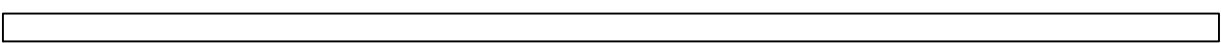
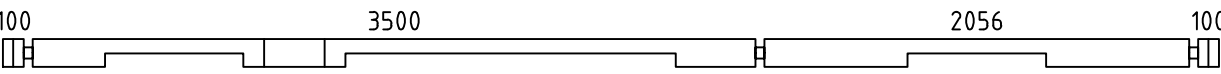
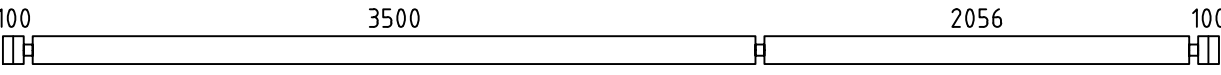
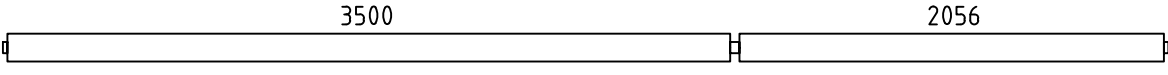
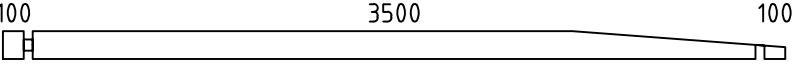
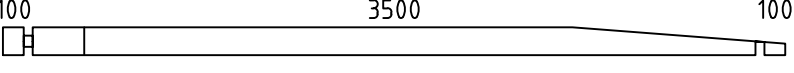
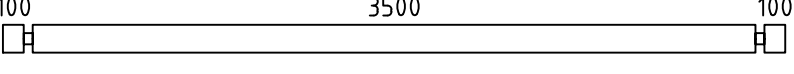
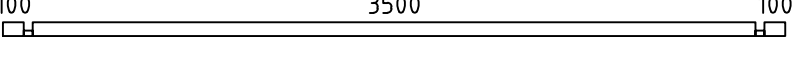
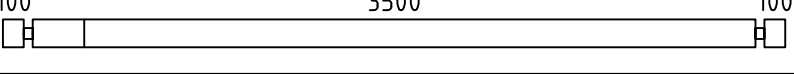
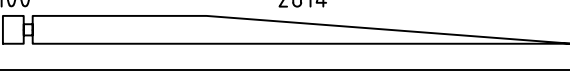
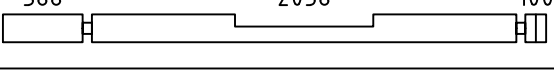
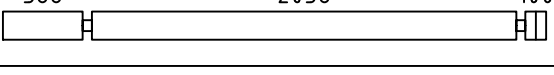
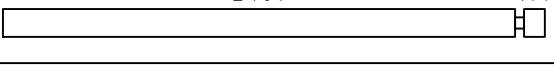
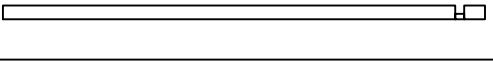
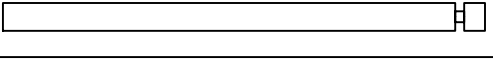
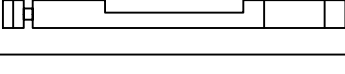
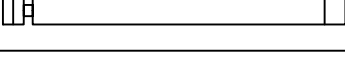
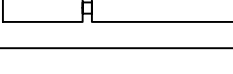
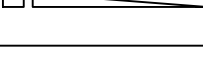
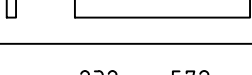
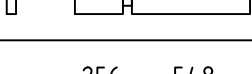
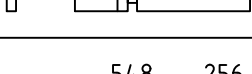
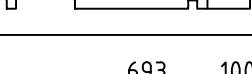
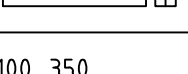
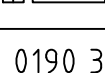

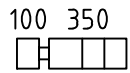
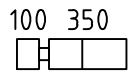



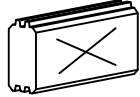

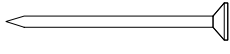
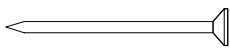
Name	VS44_0190 376x587/44 Keira L		
Zeichnung/Drawing	WAND/WALL 1		
Maßstab/Scale	1:40	Profil/Profile	4.4x13.5
		Druck auf/ Print on	A4
		Datum/Date	01.07.2024

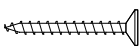
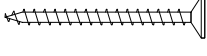
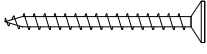
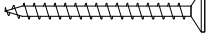
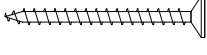

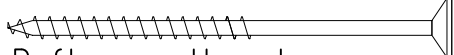
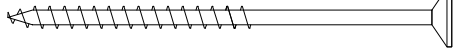
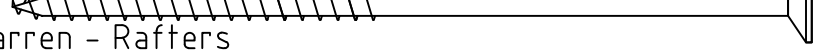
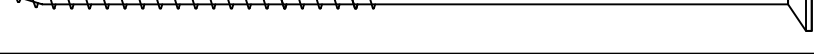
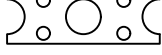
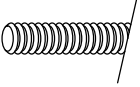
Pos	Teileliste/Specification VS44_0190 376x587/44 Keira L	Stck Pcs.	Profil Profile (mm)	Länge Length (mm)
	<u>Achtung!</u> Die Giebelbohlen können teilweise schon vormontiert sein! Bitte beachten - diese erscheinen nicht ganz so wie in der Teileliste beschrieben.			
	<u>Notice!</u> The gable pieces can be partly pre-assembled! Please notice - those differ from the description given in the specification list.			
1extra		1	44x135	5888
001		1	44x135	5888
002		14	44x135	5888
003		2	44x135	5644
004		1	44x135	3788
005		2	44x135	3788
006		15	44x135	3788
007		2	44x68	3788
008		1	44x135	3788
009		3	44x135	2758
010		1	44x135	2630
011		1	44x135	2630
012		14	44x135	2624
013		1	44x68	2334
014		15	44x135	2334
015		1	44x135	1658
016		1	44x135	1658
017		13	44x135	1123
018		3	44x75	986
019		8	44x135	848
020		2	44x135	848
021		2	44x135	848
022		2	44x135	848
023		13	44x135	837
024		13	44x135	494
Kood	VS44_0190 376x587/44 Keira L	Materjal		Leht 1/6

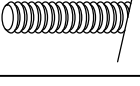
Pos	Teileliste/Specification VS44_0190 376x587/44 Keira L	Stck Pcs.	Profil Profile (mm)	Länge Length (mm)
025		17	44x135	494
026		8	44x135	494
027		4	44x135	494
028		7	44x135	494
029		4	44x135	494
030		2	44x135	494
031		1	44x68	494
032		4	44x135	322
FH2	FUNDAMENTHOLZ (imprägniert) - FOUNDATION BEAM (impregnated) 	2	70x45	5668
FH3	FUNDAMENTHOLZ (imprägniert) - FOUNDATION BEAM (impregnated) 	5	70x45	3451
FH1	FUNDAMENTHOLZ (imprägniert) - FOUNDATION BEAM (impregnated) 	3	70x45	3428
FH4	FUNDAMENTHOLZ (imprägniert) - FOUNDATION BEAM (impregnated) 	5	70x45	2007
FH5	FUNDAMENTHOLZ (imprägniert) - FOUNDATION BEAM (impregnated) 	1	70x45	1485
SPR1	SPARREN - RAFTERS 	8	44x145	4713
	DACHBRETTER - ROOF BOARDS 	42+1	113x18	3590
	DACHBRETTER - ROOF BOARDS 	42+1	113x18	2698
	FUSSBODENBRETTER - FLOOR BOARDS 	50+1	113x18	3495
	DECKENLEISTEN - CEILING STRIPS  ✓		15x28	34,0 lfm/rm
	FUSSBODENLEISTEN - FLOOR STRIPS  ✓		18x40	27,0 lfm/rm
G01-1	GIEBELBRETTER - GABLE BOARDS 18x95  ✓	4	18x95	4752
G05-1	GIEBELDECKLEISTEN - GABLE COVER STRIPS 18x40  ✓	2	18x40	4702
T01-1	TRAUFBRETTER - EAVES BOARDS 18x95 	4	18x95	3144
T01-2	TRAUFBRETTER - EAVES BOARDS 18x95 	4	18x95	3162
T04-1	TRAUFENDECKLEISTEN - EAVES COVER STRIPS 18x40 	2	18x40	3162
T06-1	TRAUFENLEISTEN - EAVES STRIPS 18x40  ✓		18x40	13,0 lfm/rm
Kood	VS44_0190 376x587/44 Keira L	Materjal		Leht 2/6

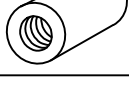
Pos	Teileliste/Specification VS44_0190 376x587/44 Keira L		Stck Pcs.	Profil Profile (mm)	Länge Length (mm)
SH	SCHLAGHÖLZER - MOUNTING PIECES		3		
ML1	Metallstange - Metal bar		7	D10	900
ML2	Metallstange - Metal bar		4	D10	770
NG2 550	NÄGEL - NAILS 2.5x50 Dachbretter - Roof boards		1008		
NG2 550	NÄGEL - NAILS 2.5x50 Fussbodenbretter - Floor boards		700		
SR3 030	Schrauben - Screws 3.0x30 Deckenleisten - Ceiling strips		68		
SR3 030	Schrauben - Screws 3.0x30 Fussbodenleisten - Floor strips		54		
SR3 030	Schrauben - Screws 3.0x30 Traufenleisten - Eaves strips		26		
SR3 545	Schrauben - Screws 3.5x45 Giebelbretter - Gable boards		44		
SR3 545	Schrauben - Screws 3.5x45 Giebeldeckleisten - Gable cover strips		22		
SR3 545	Schrauben - Screws 3.5x45 Traufenbretter - Eaves boards		64		
SR3 545	Schrauben - Screws 3.5x45 Traufendeckleisten - Eaves cover boards		16		
SR354 5-001	Schrauben - Screws 3.5x45 Verbindungsstreifen - Connecting strip		16		
SR57	Schrauben - Screws 5.0x100 Sparren an die Dachkanten - Rafters on the edges		8		
SR5 0100	Schrauben - Screws 5.0x100 Fundamenthölzer - Foundation beams		64		
SR63	Schrauben - Screws 6.0x180 Sparren - Rafters		12		
SR63	Schrauben - Screws 6.0x180 Pos - Log 003, 019, 020, 021, 022		20		
VS	Verbindungsstreifen für verbinden der Wandbohlen - Connecting strip for connecting the wall parts		4		
KL1	Gewindestange - Threaded Rod M8		4		2000
KL2	Gewindestange - Threaded Rod M8		2		460
KL3	Gewindestange - Threaded Rod M8		2		190
KV M UT M8	Mutter - Nut M8		8		
KV S EIB M8X25	U-Scheibe - Washer M8 Ø25		8		
KV MU TJ M8	Befestigungsmutter - Fixing nut M8		4		
	✓ - Bitte selber anpassen (falls nötig)! / Cut into length on site (if needed)!				
Kood	VS44_0190 376x587/44 Keira L		Materjal		Leht 3/6







Aken	Q4-Q6	-	paigaldusjuhhis
Window	Q4-Q6	-	assembly instructions
Fenster	Q4-Q6	-	Montageanleitung

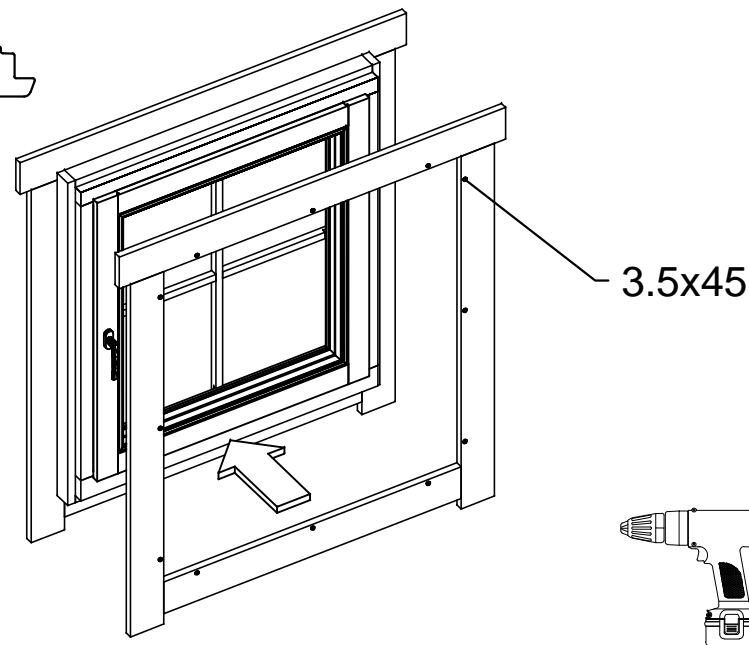
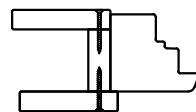
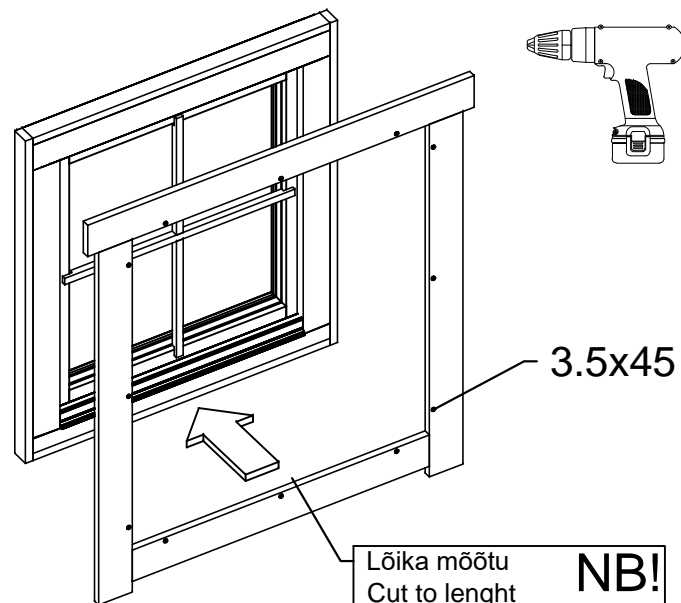
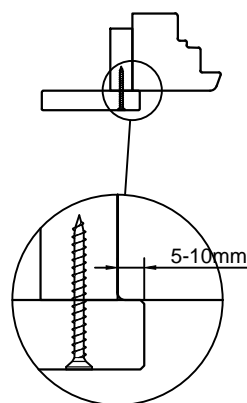
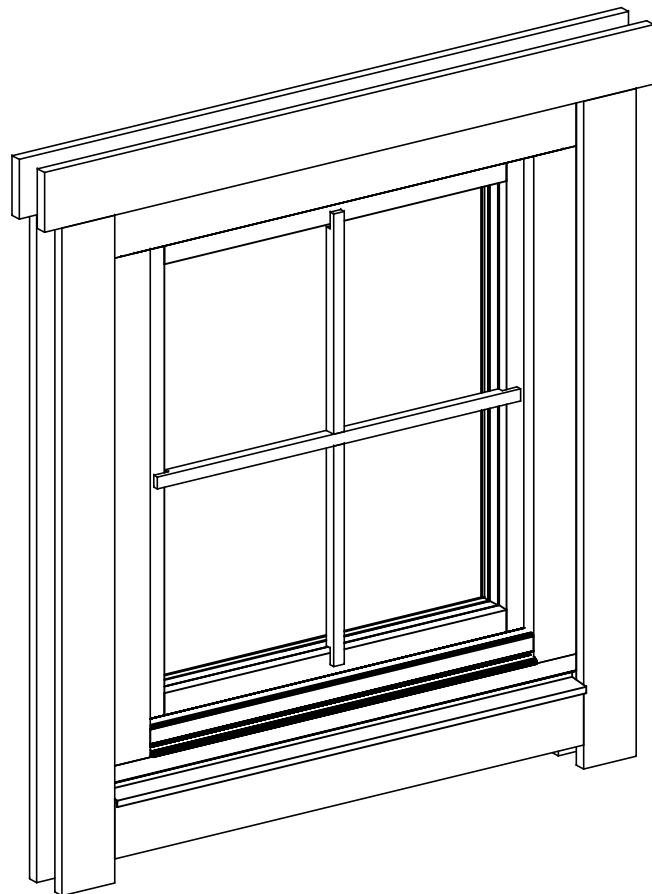

Ukse montaa 0 / Tür montage / Door assembly  
(GH+ / SH)

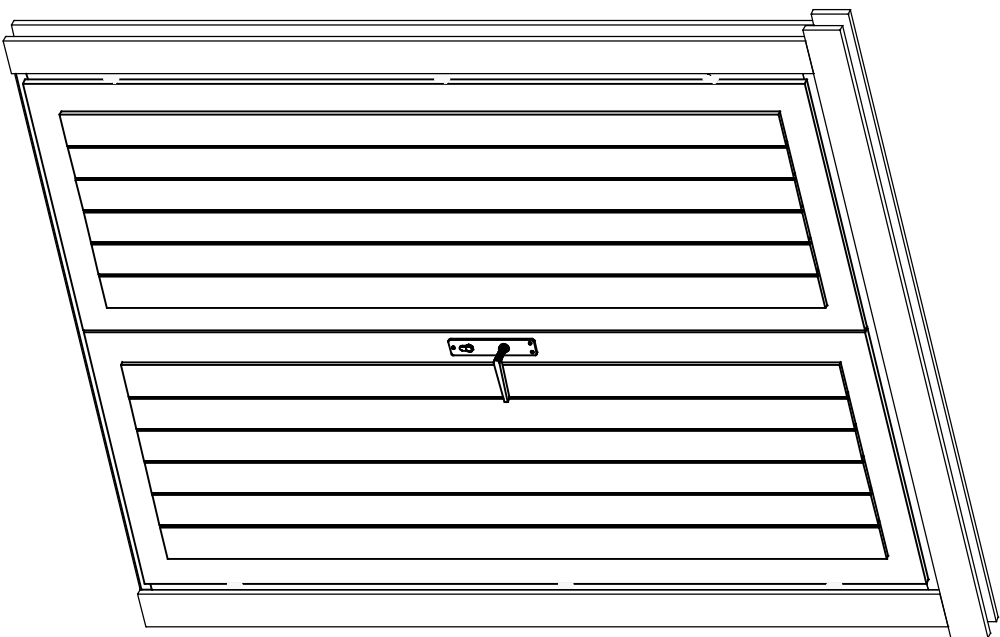

4.5x90

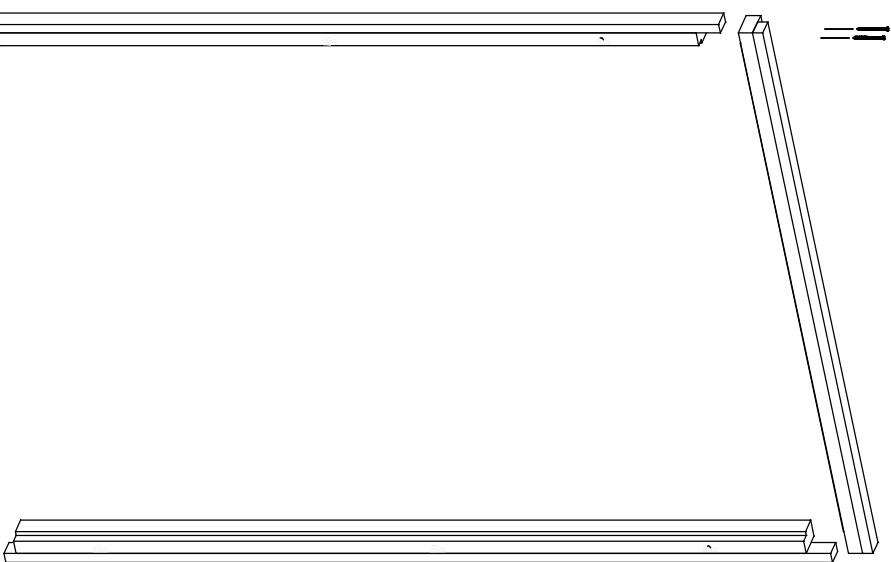

4.5x90



