

Das Haus lässt sich auch spiegeverkehrt aufbauen.  
Cabin can be built mirrored.

Name	Starla D Alu 325x427+VD/44		
Zeichnung/Drawing	3D		
Profil/Profile	4.4x13.5	Datum/Date	06.06.2023

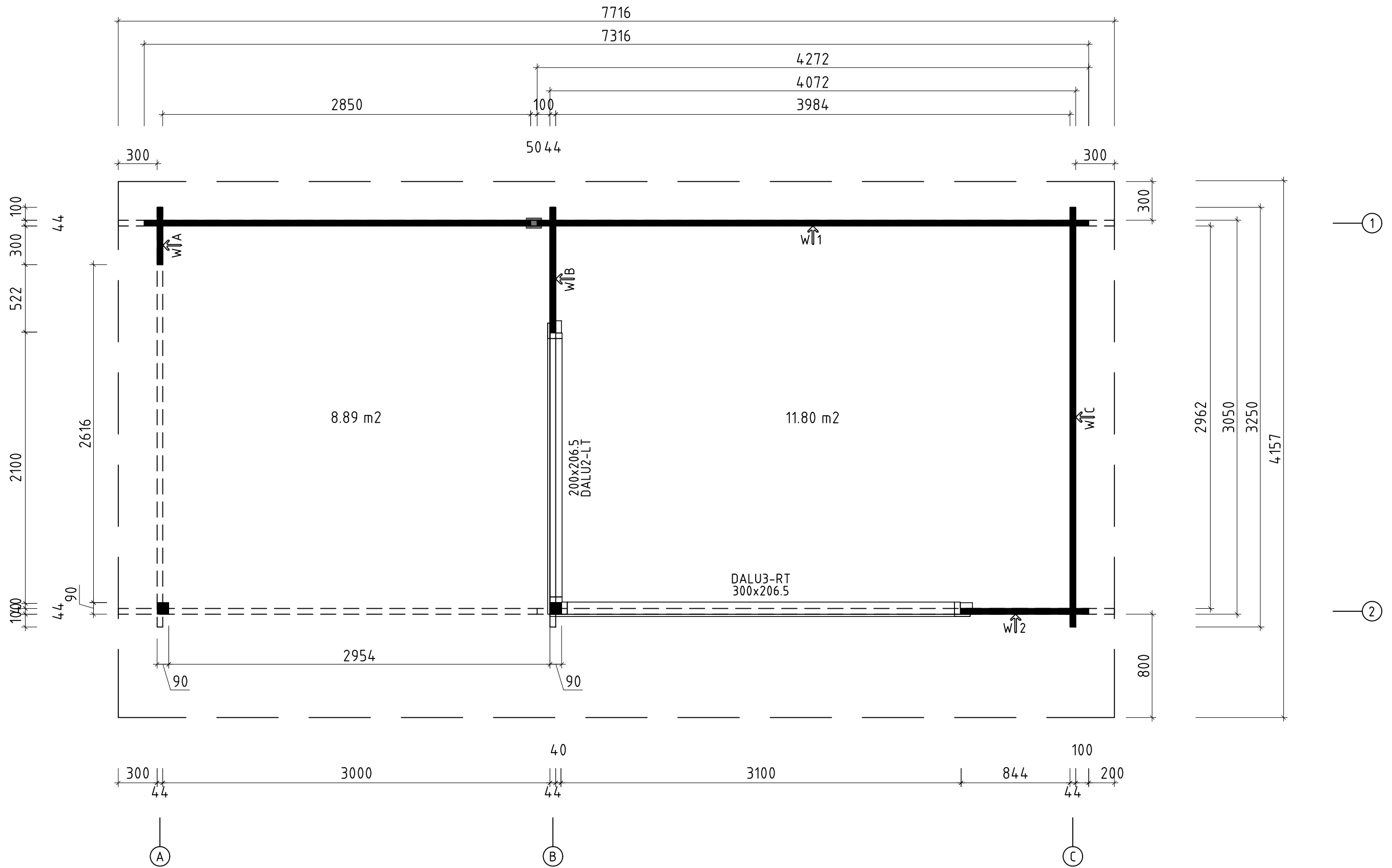

Q0 – Qualitätsklasse für Fenster und Türen/  
Quality class for windows and doors

\* Fenster und Türen sind ohne Sprossen  
Windows and doors are without muntins

Name	Starla D Alu 325x427+VD/44		
Zeichnung/Drawing	Grundplan; Plan		
Profil/Profile	4.4x13.5	Datum/Date	06.06.2023

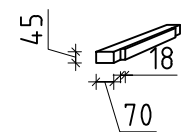
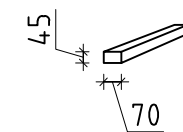
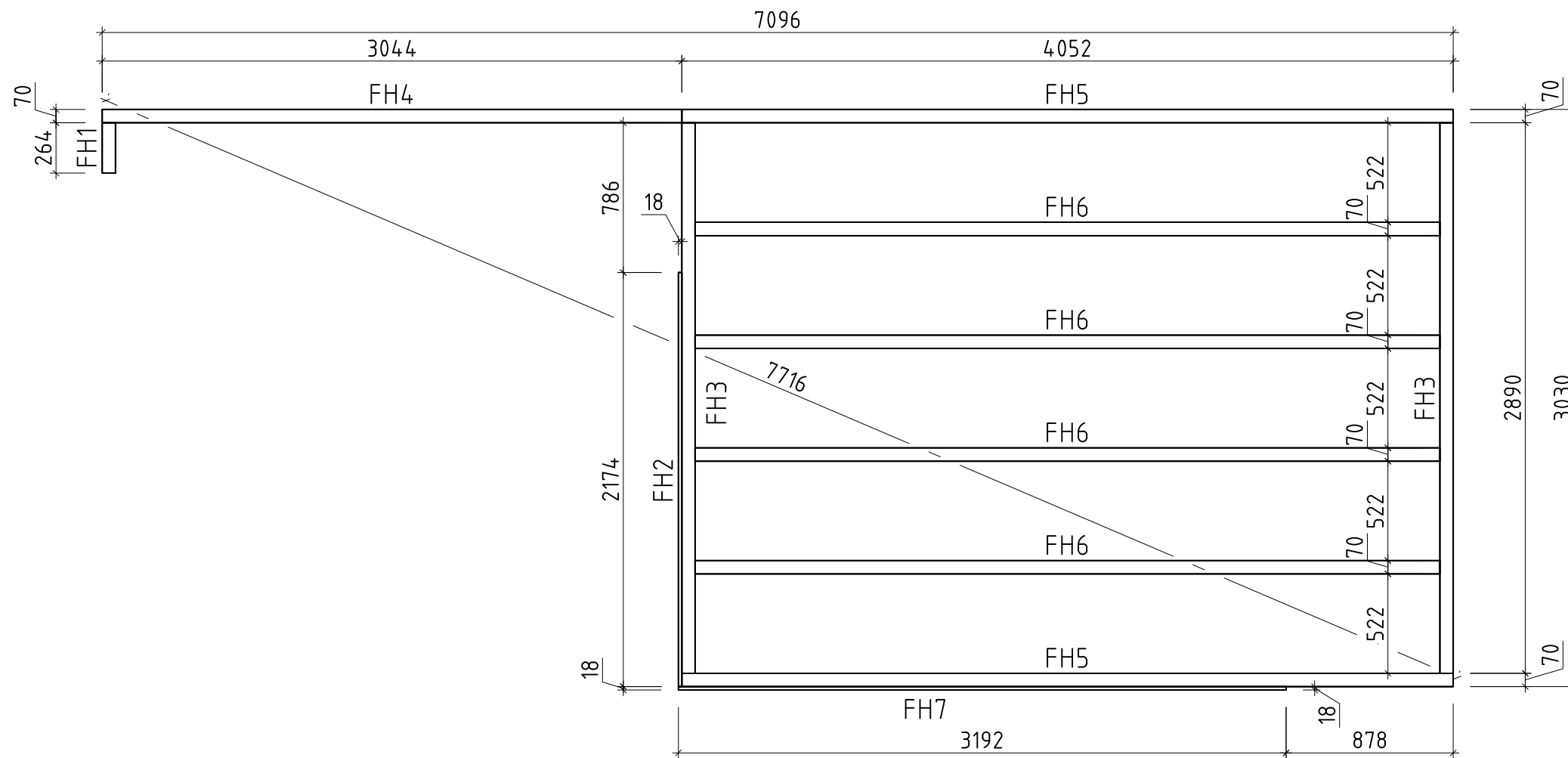

Name	Starla D Alu 325x427+VD/44		
Zeichnung/Drawing	Grundplan; Plan		
Profil/Profile	4.4x13.5	Datum/Date	06.06.2023

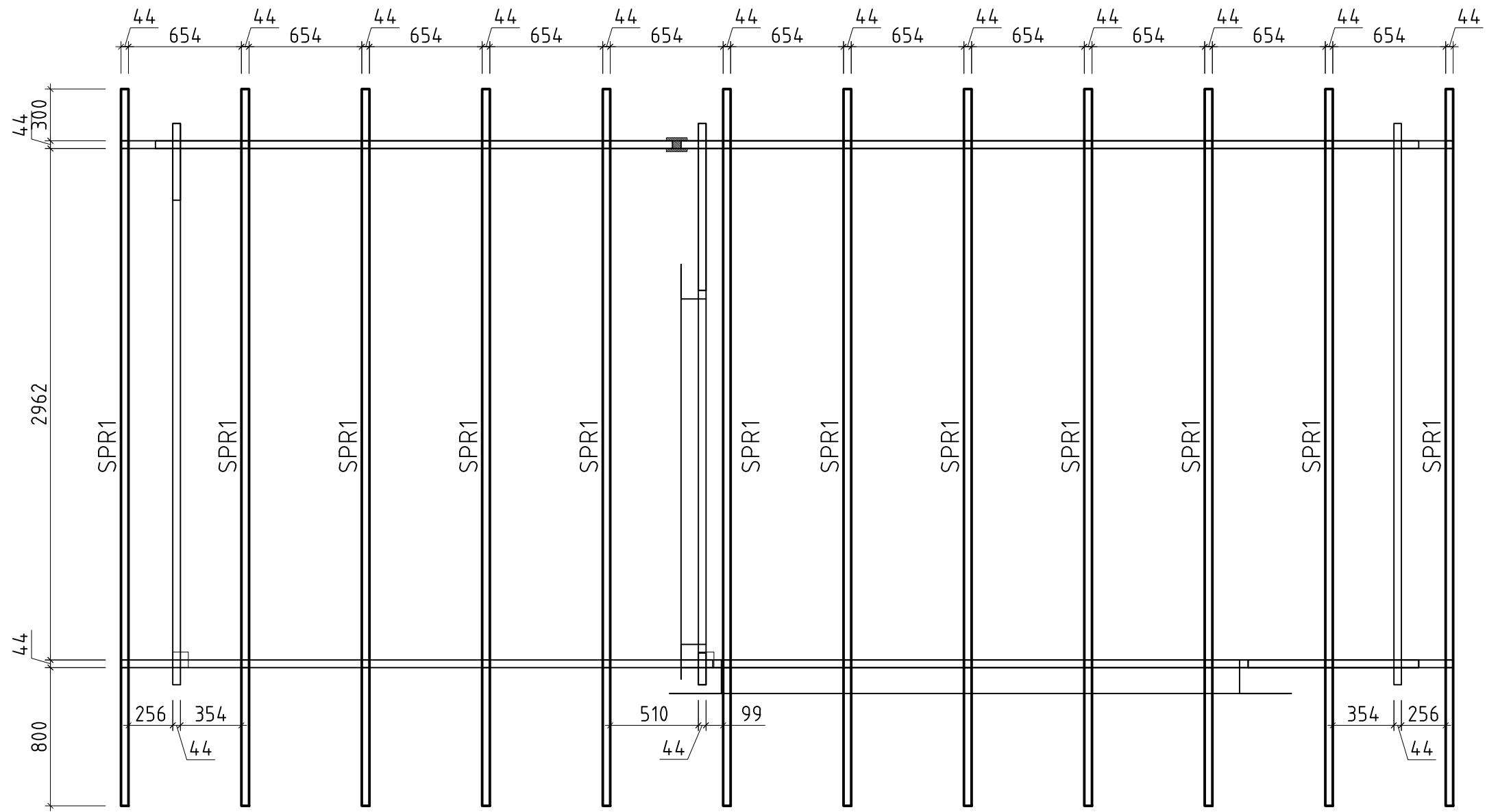

Name	Starla D Alu 325x427+VD/44		
Zeichnung/Drawing	Sparren; Rafters		
Profil/Profile	4.4x13.5	Datum/Date	06.06.2023

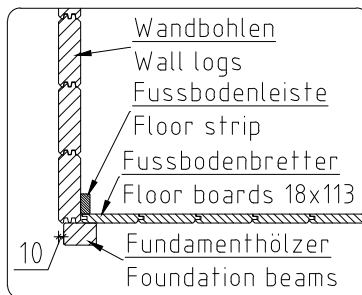
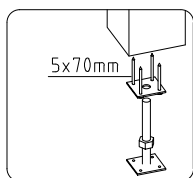
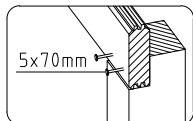
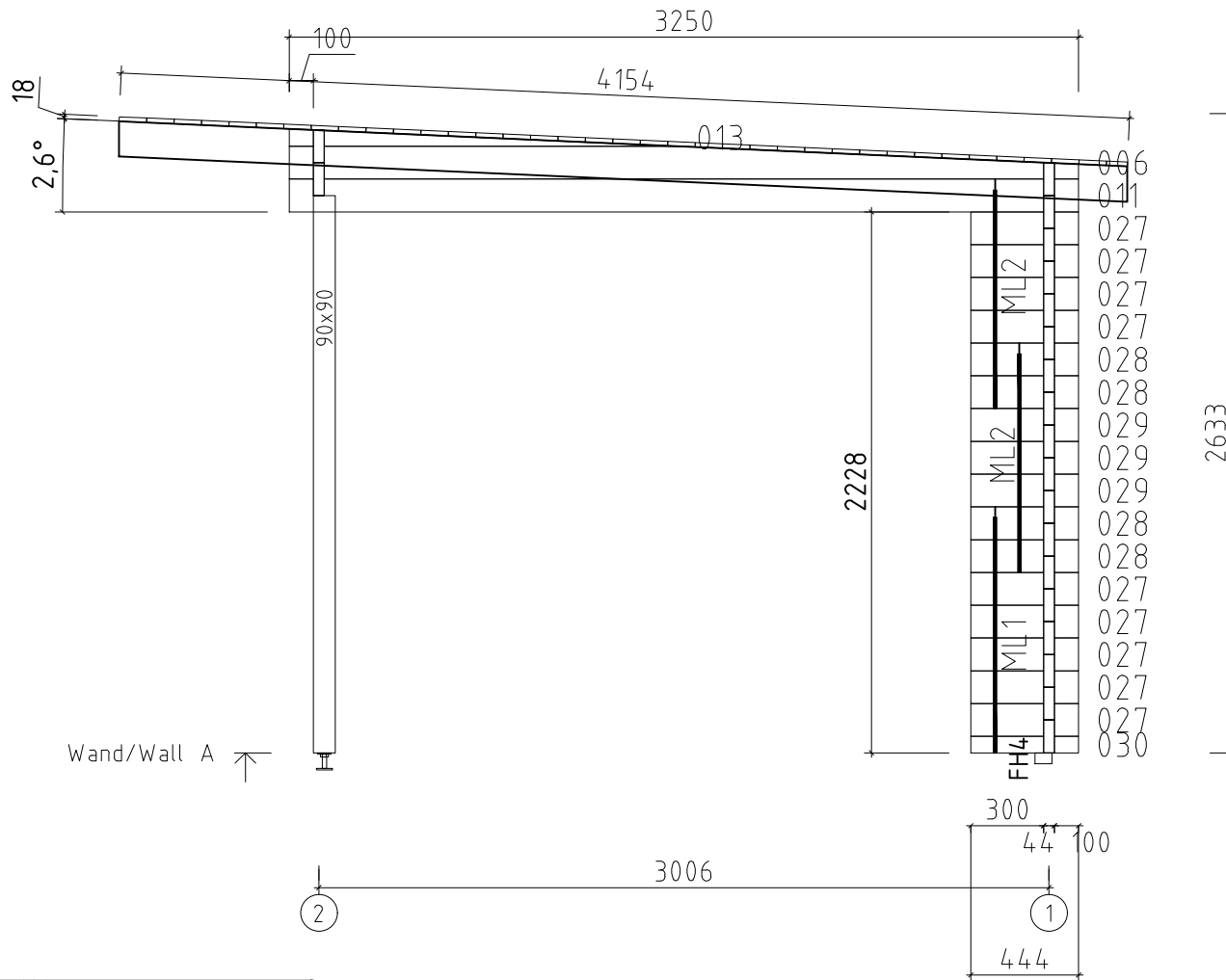
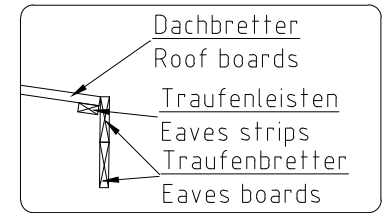
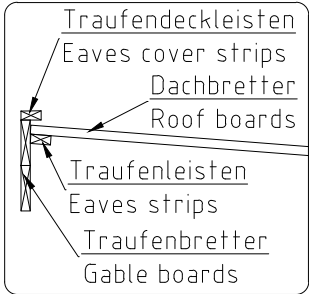

Name	Starla D Alu 325x427+VD/44	
Zeichnung/Drawing	WAND/WALL A	
Profil/Profile	4.4x13.5	Datum/Date 06.06.2023

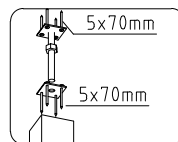
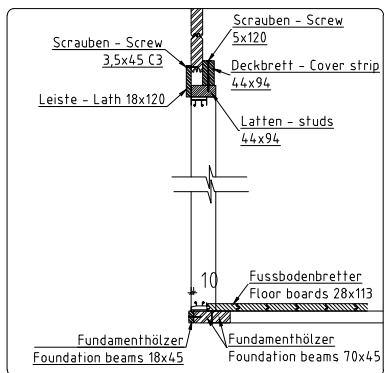
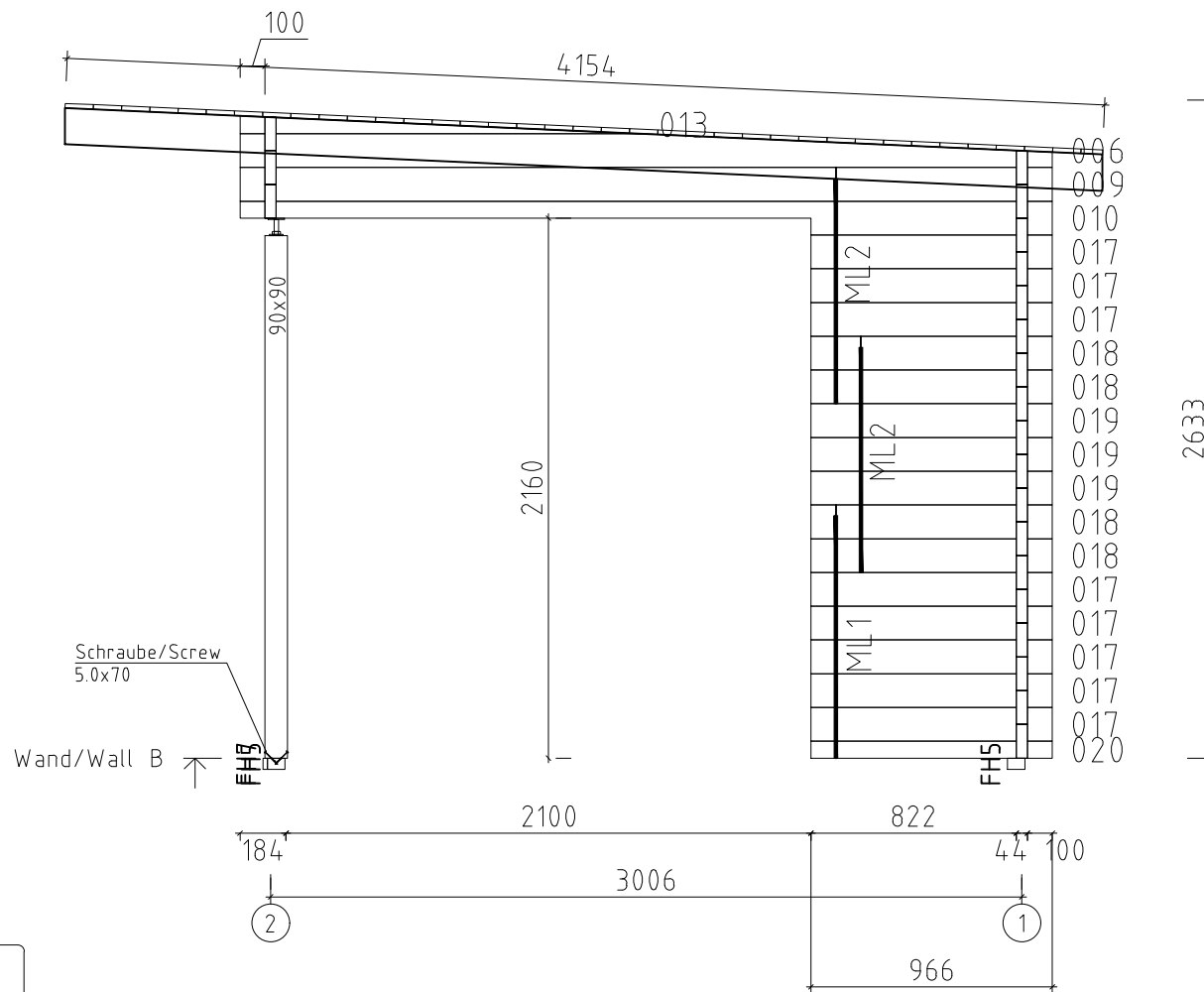







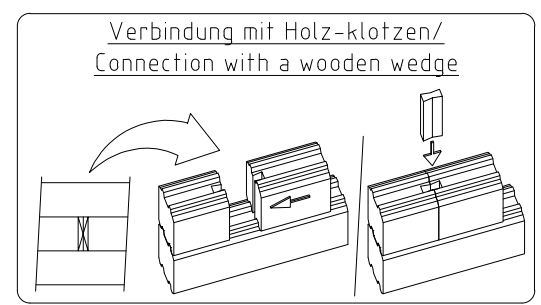
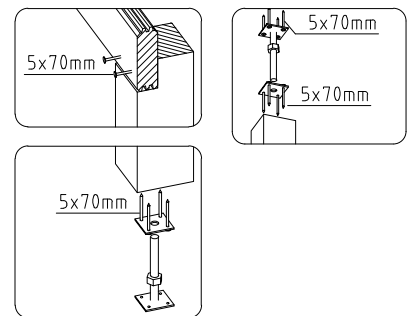
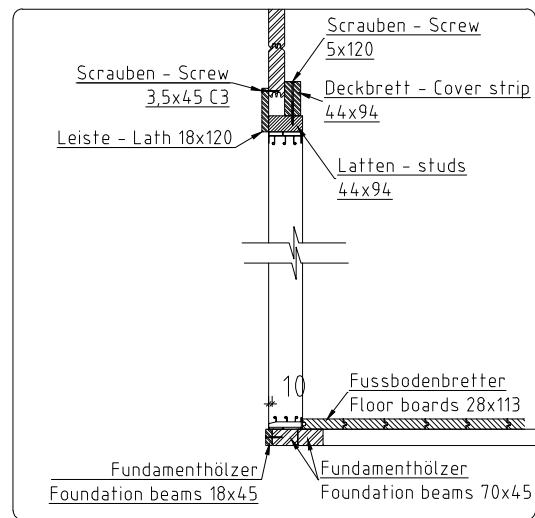
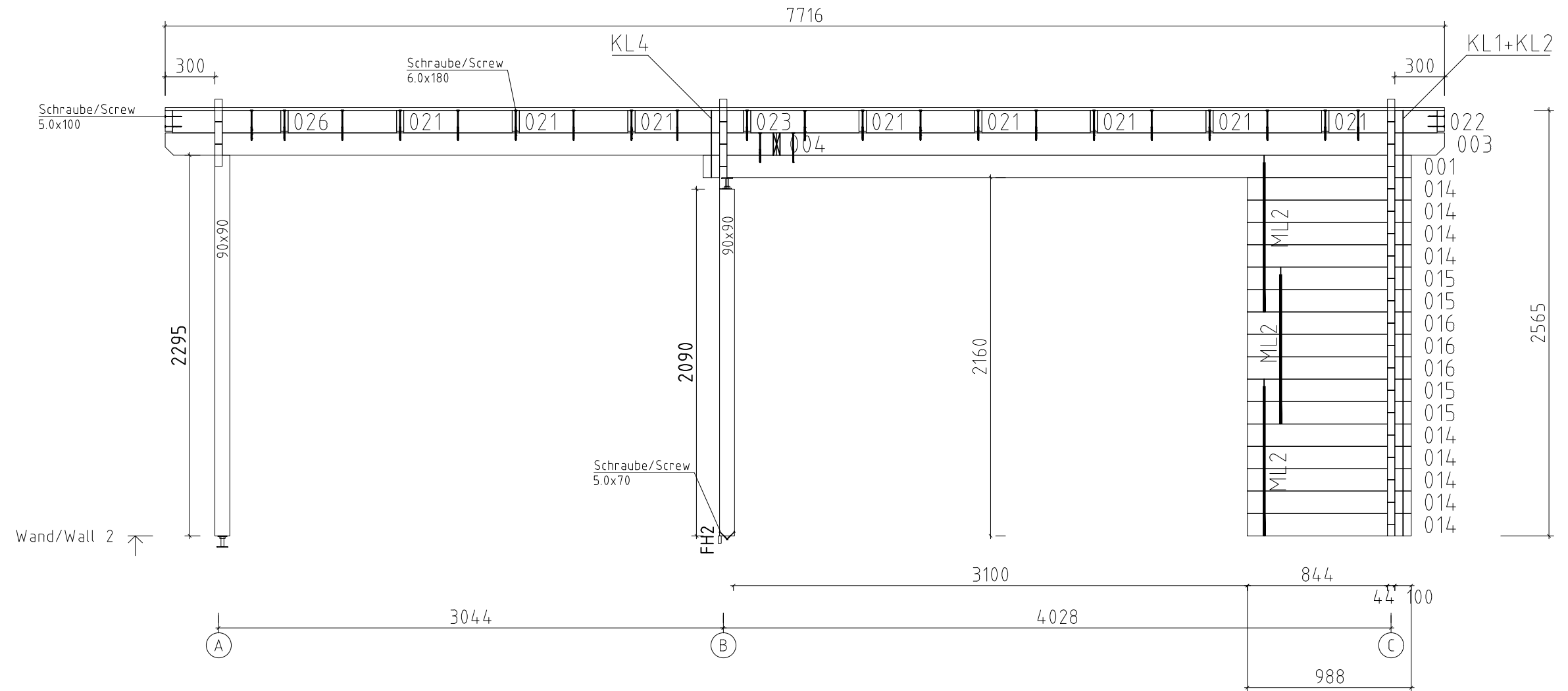



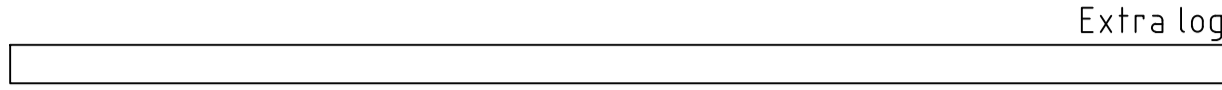
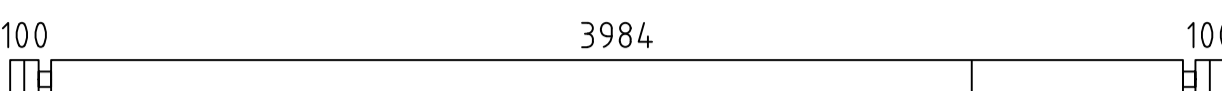
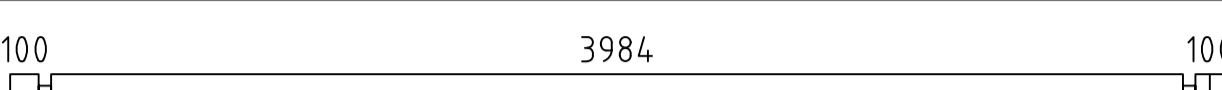
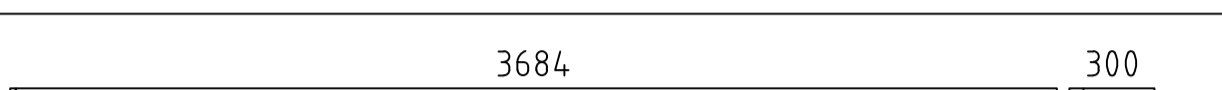
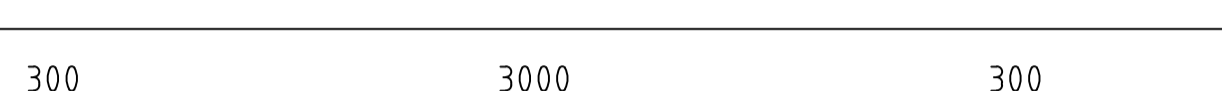
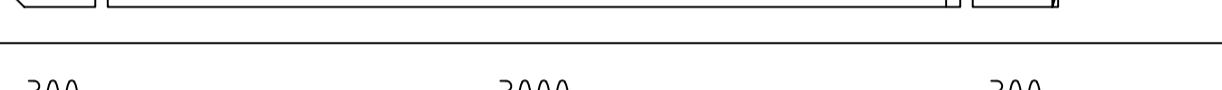
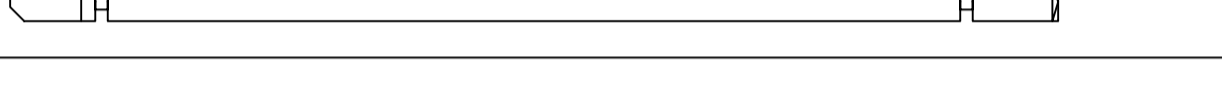
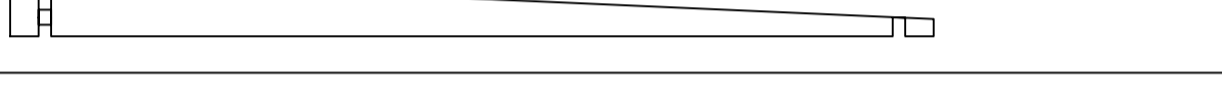
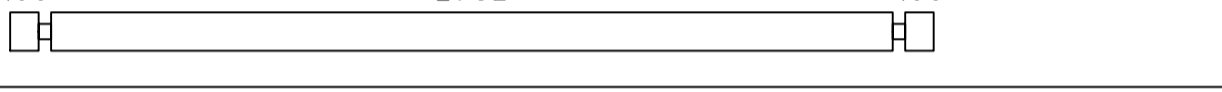
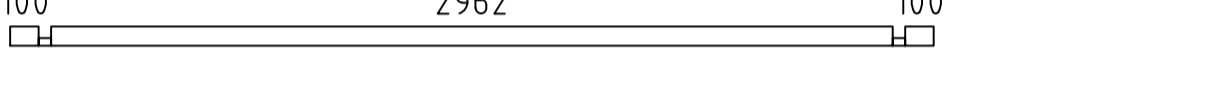
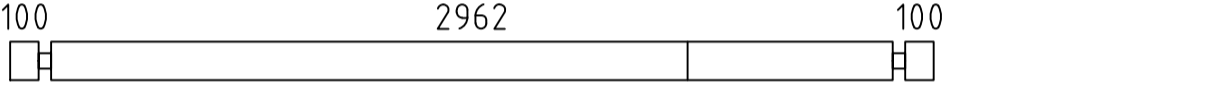
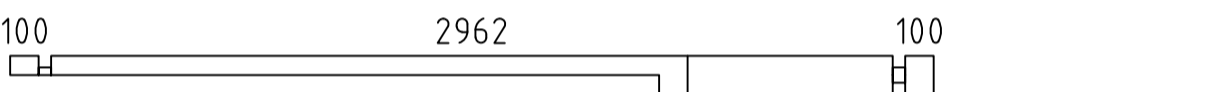

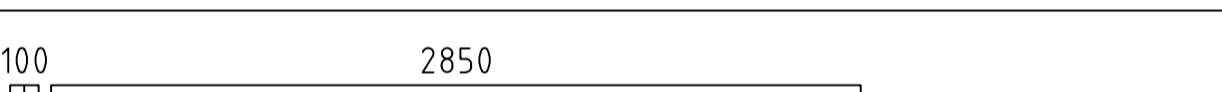
Name	Starla D Alu 325x427+VD/44	
Zeichnung/Drawing	WAND/WALL B	
Profil/Profile	4.4x13.5	Datum/Date 06.06.2023

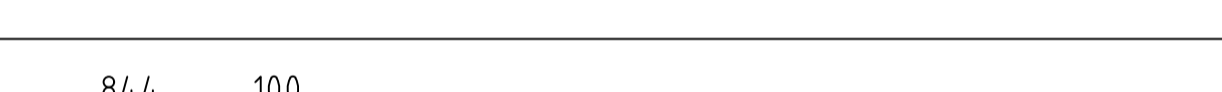

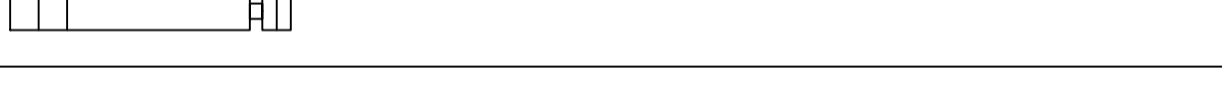





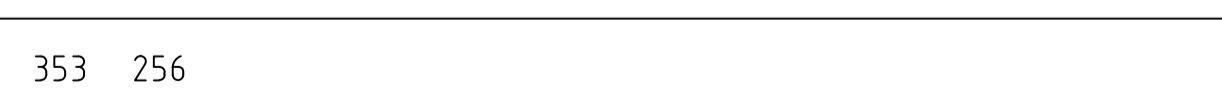
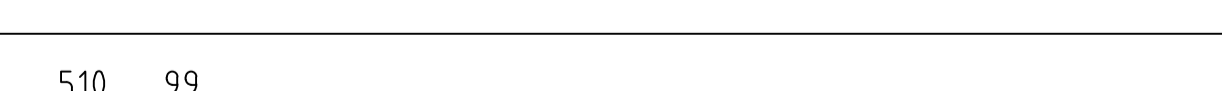



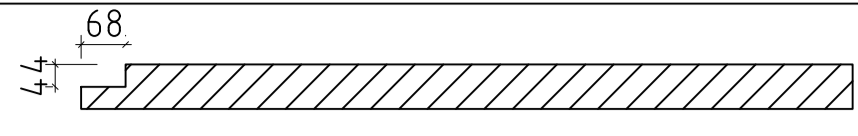

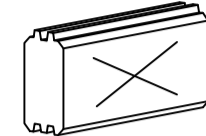
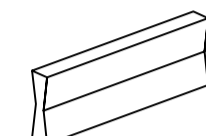
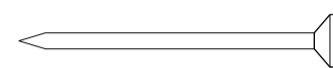

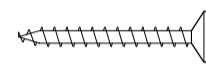
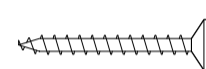
Name	Starla D Alu 325x427+VD/44		
Zeichnung/Drawing	WAND/WALL 2		
Profil/Profile	4.4x13.5	Datum/Date	06.06.2023

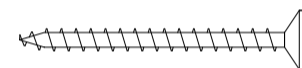
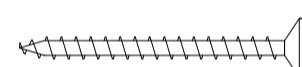
Pos	Teieliste/Specification Starla D Alu 325x427+VD/44	Stck Pcs.	Profil Profile (mm)	Länge Length (mm)
	<u>Achtung!</u> Die Giebelbohlen können teilweise schon vormontiert sein! Bitte beachten - diese erscheinen nicht ganz so wie in der Teieliste beschrieben.			
	<u>Notice!</u> The gable pieces can be partly pre-assembled! Please notice - those differ from the description given in the specification list.			
000	 Extra log	1	44x135	4272
001		1	44x135	4272
002		16	44x135	4272
003		2	44x135	4028
004		1	44x135	3688
005		1	44x135	3688
006		3	44x135	3250
007		17	44x135	3250
008		1	44x68	3250
009		1	44x135	3250
010		1	44x135	3250
011		1	44x135	3250
012		16	44x135	2994
013		3	44x72	1603
014		9	44x135	988
015		4	44x135	988
016		3	44x135	988
017		8	44x135	966
018		4	44x135	966
019		3	44x135	966
020		1	44x68	966
021		16	44x135	653
022		2	44x135	653
023		1	44x135	653
024		1	44x135	653
025		1	44x135	653
Kood	Starla D Alu 325x427+VD/44	Materjal		Leht 1/5

Pos	Teileliste/Specification Starla D Alu 325x427+VD/44		Stck Pcs.	Profil Profile (mm)	Länge Length (mm)		
026			1	44x135	653		
027			9	44x135	444		
028			4	44x135	444		
029			3	44x135	444		
030			1	44x68	444		
FH5	FUNDAMENTHOLZ (imprägniert) - FOUNDATION BEAM (impregnated) 		2	70x45	4052		
FH6	FUNDAMENTHOLZ (imprägniert) - FOUNDATION BEAM (impregnated) 		4	70x45	3912		
FH4	FUNDAMENTHOLZ (imprägniert) - FOUNDATION BEAM (impregnated) 		1	70x45	3044		
FH3	FUNDAMENTHOLZ (imprägniert) - FOUNDATION BEAM (impregnated) 		2	70x45	2890		
FH1	FUNDAMENTHOLZ (imprägniert) - FOUNDATION BEAM (impregnated) 		1	70x45	264		
FH7	FUNDAMENTHOLZ (imprägniert) - FOUNDATION BEAM (impregnated) 		1	18x45	3192		
FH2	FUNDAMENTHOLZ (imprägniert) - FOUNDATION BEAM (impregnated) 		1	18x45	2174		
SPR1	SPARREN - RAFTERS 		12	44x145	4161		
	DACHBRETTER - ROOF BOARDS		✓	113x18	306,0 lfm/rm		
	FUSSBODENBRETTER - FLOOR BOARDS		36+1	113x18	2957		
	DECKENLEISTEN - CEILING STRIPS		✓	15x28	27,0 lfm/rm		
	FUSSBODENLEISTEN - FLOOR STRIPS		✓	18x40	16,0 lfm/rm		
A44-1	ADAPTER 44	Obere seite Upper side 		✓	1	80x120	2295
G01-1	GIEBELBRETTER - GABLE BOARDS 18x95		✓	4	18x95	4204	
G05-1	GIEBELDECKLEISTEN - GABLE COVER STRIPS 18x40		✓	2	18x40	4154	
T01-1	TRAUFBRETTER - EAVES BOARDS 18x95			4	18x95	3858	
T01-2	TRAUFBRETTER - EAVES BOARDS 18x95			4	18x95	3876	
T04-1	TRAUFENDECKLEISTEN - EAVES COVER STRIPS 18x40			2	18x40	3876	
T06-1	TRAUFENLEISTEN - EAVES STRIPS 18x40		✓		18x40	16,0 lfm/rm	
TP90-1	STÜTZPFOSTE - SUPPORT POST 90x90		✓	1	90x90	2090	
Kood	Starla D Alu 325x427+VD/44		Materjal		Leht 2/6		

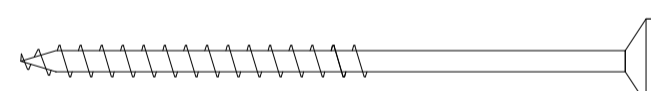
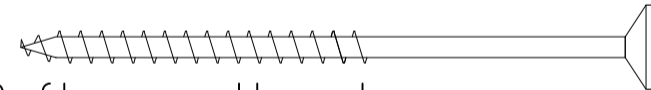
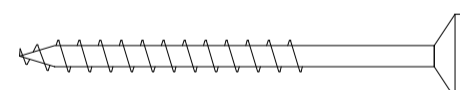
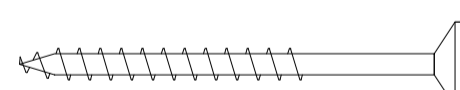
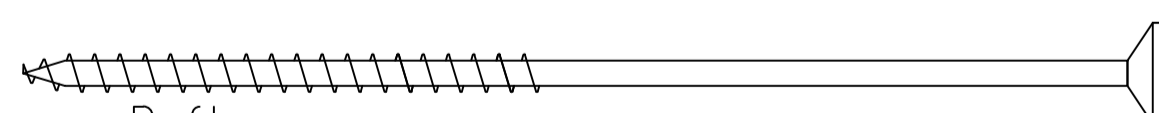
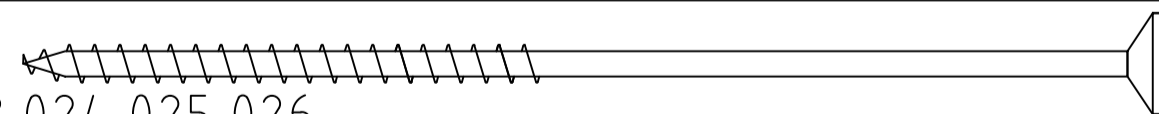
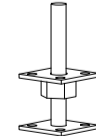
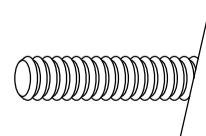
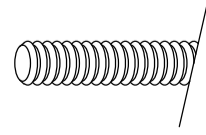
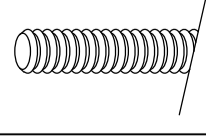
Pos	Teileliste/Specification Starla D Alu 325x427+VD/44		Stck Pcs.	Profil Profile (mm)	Länge Length (mm)
TP9 0-2	STÜTZPFOSTE - SUPPORT POST 90x90		1	90x90	2295
ML1	Metallstange - Metal bar		2	D10	970
ML2	Metallstange - Metal bar		7	D10	900
SH	SCHLAGHÖLZER - MOUNTING PIECES		3		
HK2	HOLZ-KLOTZEN für verbinden der Wandbohlen - Wooden wedge for connecting the wall parts (122mm)		2		
NG2 550	NÄGEL - NAILS 2.5x50 Dachbretter - Roof boards		962		
NG2 550	NÄGEL - NAILS 2.5x50 Fussbodenbretter - Floor boards		432		
SR3 030	Schrauben - Screws 3.0x30 Deckenleisten - Ceiling strips		54		
SR3 030	Schrauben - Screws 3.0x30 Fussbodenleisten - Floor strips		32		
SR3 030	Schrauben - Screws 3.0x30 Traufenleisten - Eaves strips		32		
SR3 545	Schrauben - Screws 3.5x45 Fundamenthölzer - Foundation beams		12		
SR3 545	Schrauben - Screws 3.5x45 Giebelbretter - Gable boards		40		
SR3 545	Schrauben - Screws 3.5x45 Giebeldeckleisten - Gable cover strips		20		
SR3 545	Schrauben - Screws 3.5x45 Traufenbretter - Eaves boards		96		
SR3 545	Schrauben - Screws 3.5x45 Traufendeckleisten - Eaves cover boards		20		
SR5 0100	Schrauben - Screws 5.0x100 Fundamenthölzer - Foundation beams		40		
SR5 0100	Schrauben - Screws 5.0x100 Sparren an die Dachkanten - Rafters on the edges		8		
SR5 070	Schrauben - Screws 5.0x70 Stützpfofte - Support post		6		
SR507 0-002	Schrauben - Screws 5.0x70 Verstellbare pfoftenstütze - Post support		12		
SR63	Schrauben - Screws 6.0x180 Sparren - Rafters		20		
SR6 0180	Schrauben - Screws 6.0x180 Pos - Log 003,004,005,021,022,023,024,025,026		26		
VP2	Verstellbare Pfoftenstütze - Adjustable post support M16		2		
KL1	Gewindestange - Threaded Rod M8		3		2000
KL2	Gewindestange - Threaded Rod M8		1		595
KL3	Gewindestange - Threaded Rod M8		2		460
Kood	Starla D Alu 325x427+VD/44		Materjal		Leht 3/6







### TÜR/DOOR 3000x2065

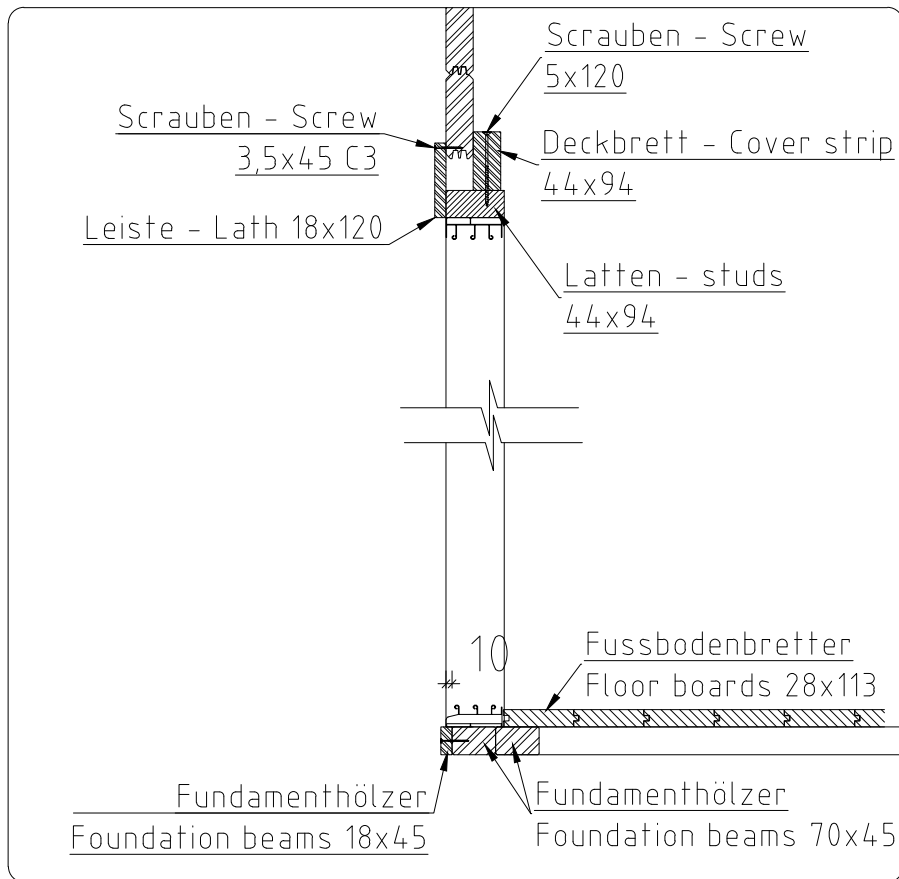

### TÜR/DOOR 2000x2065

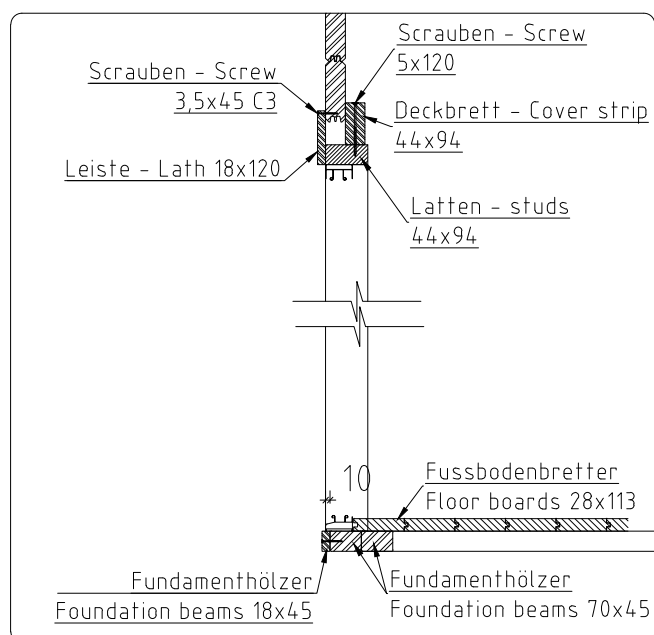

# DALU-RT - Installation instructions / Aufbauanleitung / Paigaldusjuhend

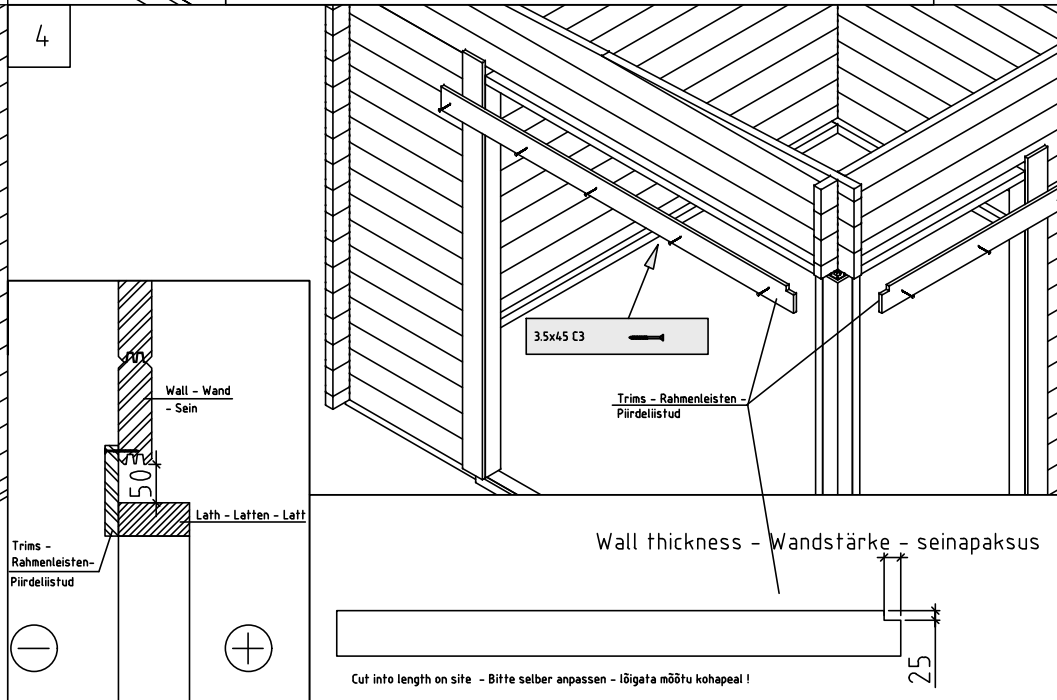
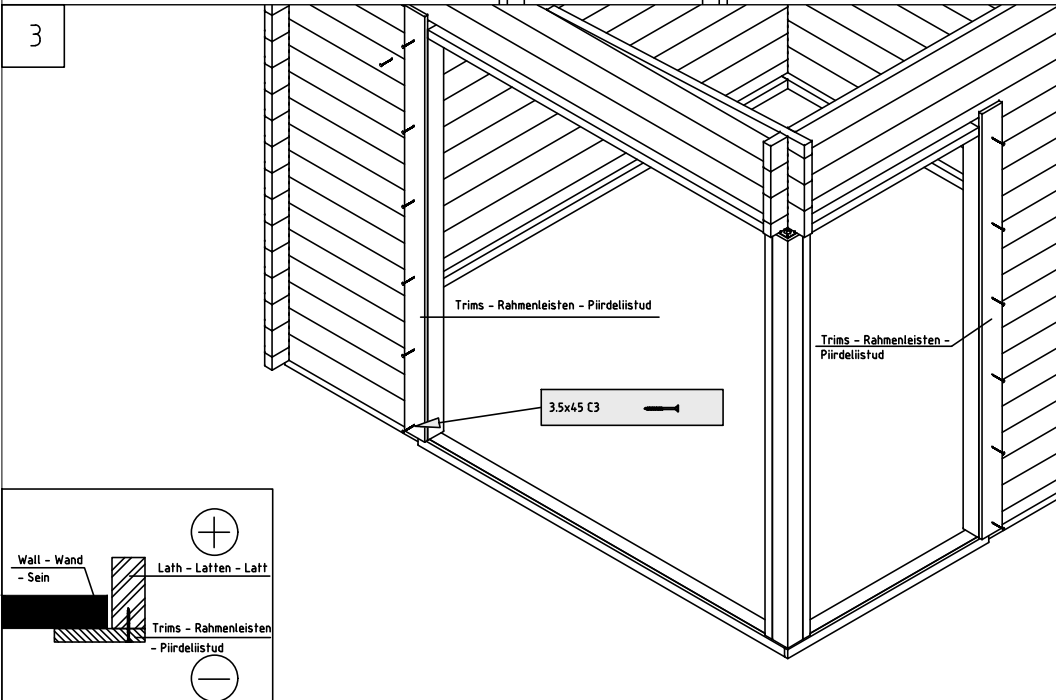
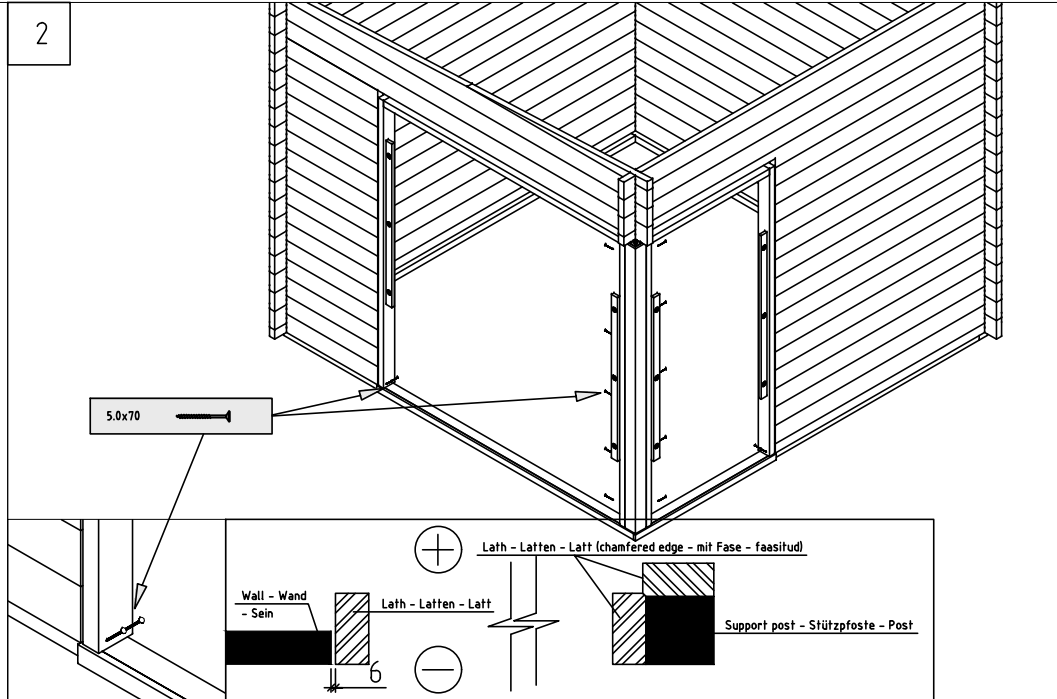
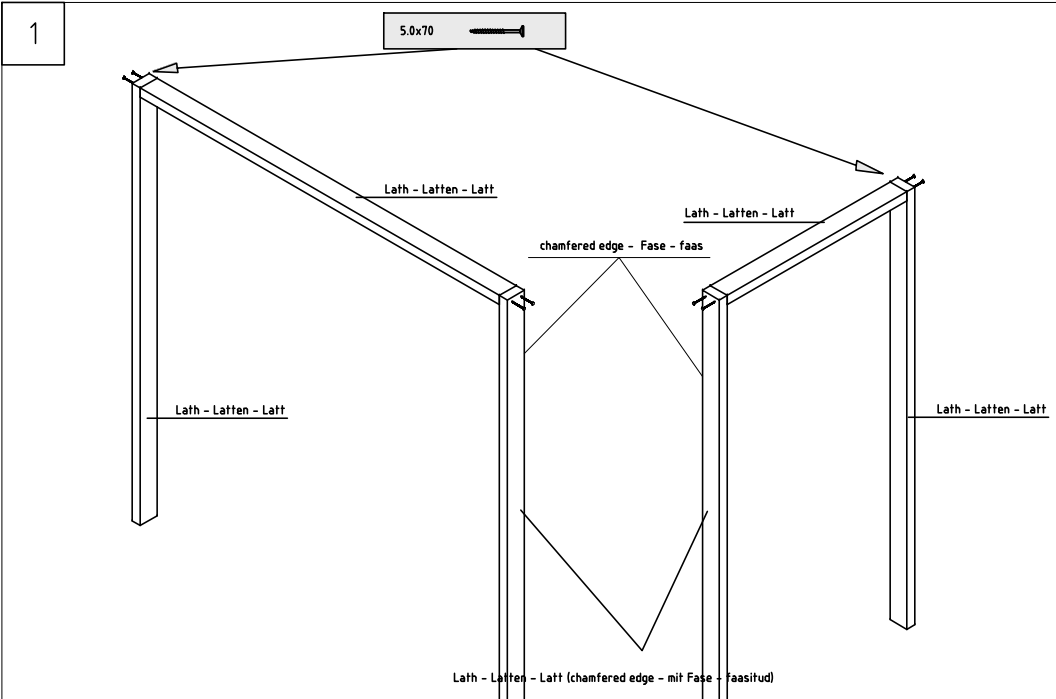

DALU-RT - Installation instructions / Aufbauanleitung / Paigaldusjuhend

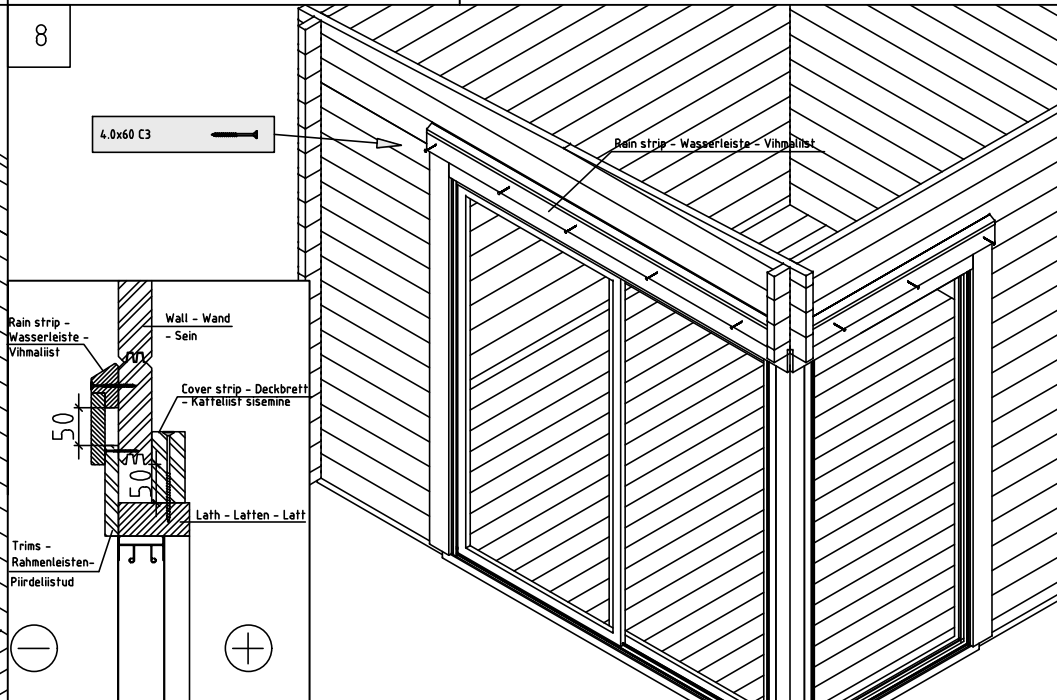
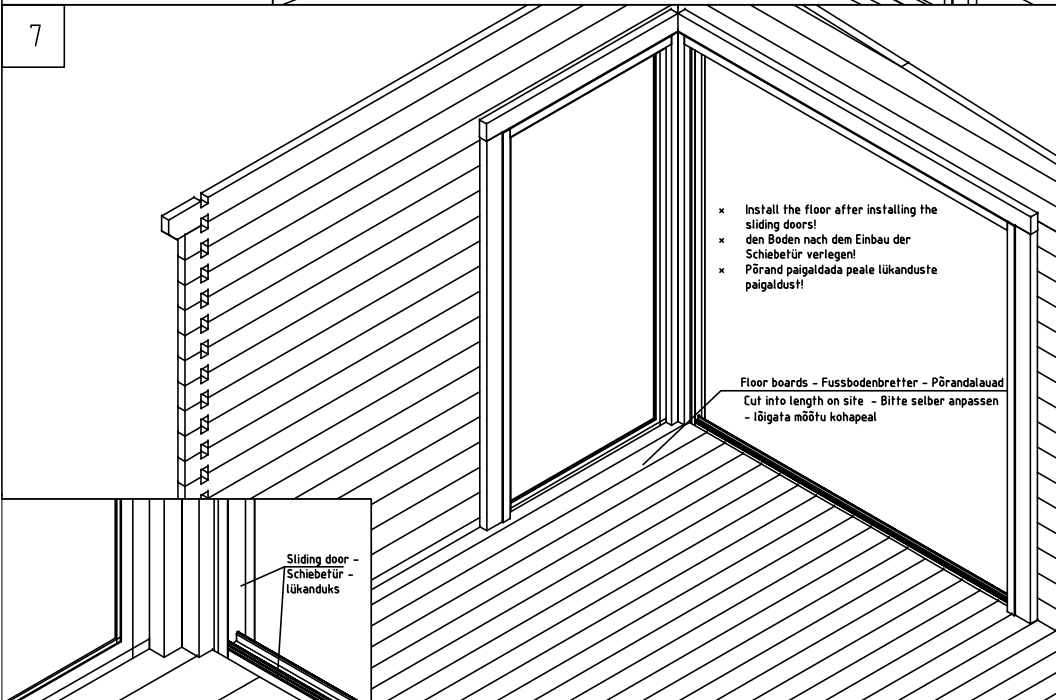
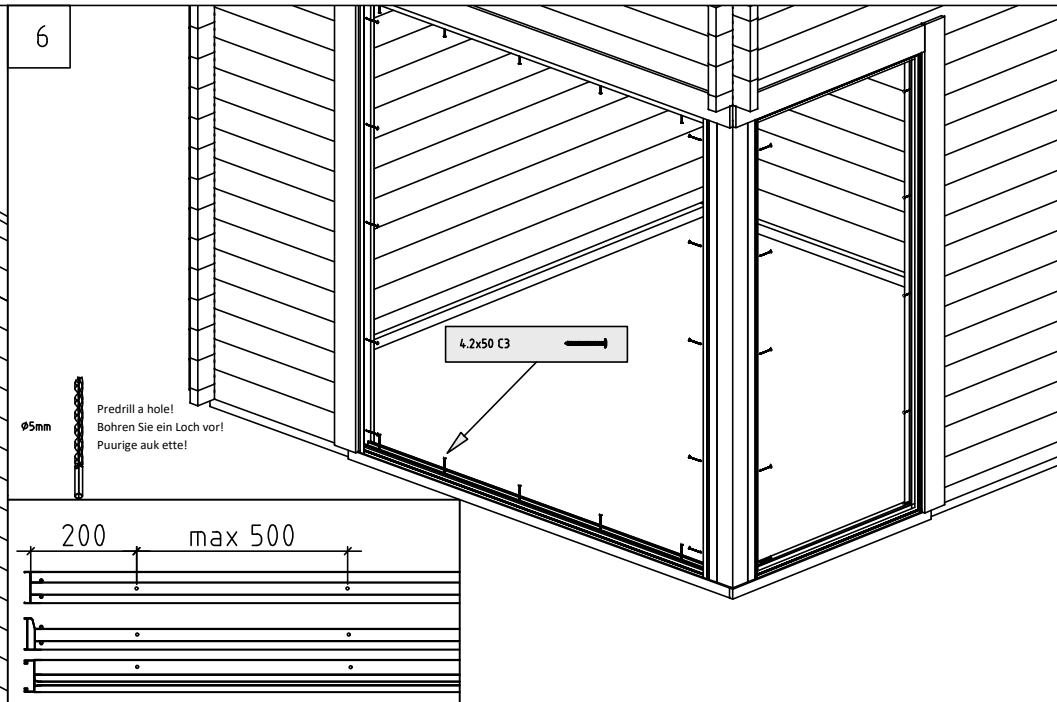
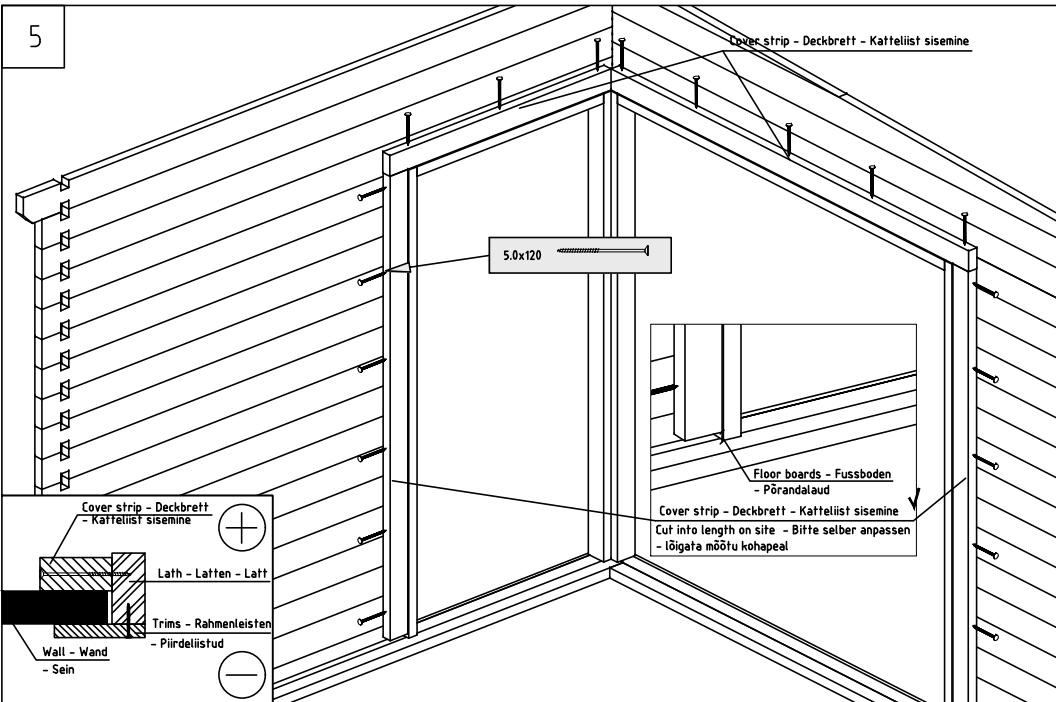

**СХЕМА СБОРКИ РАМЫ**

