

Name

Erkki 595x530; 44

Zeichnung/Drawing

3D

Profil/Profile

4.4x13.5





Datum/Date

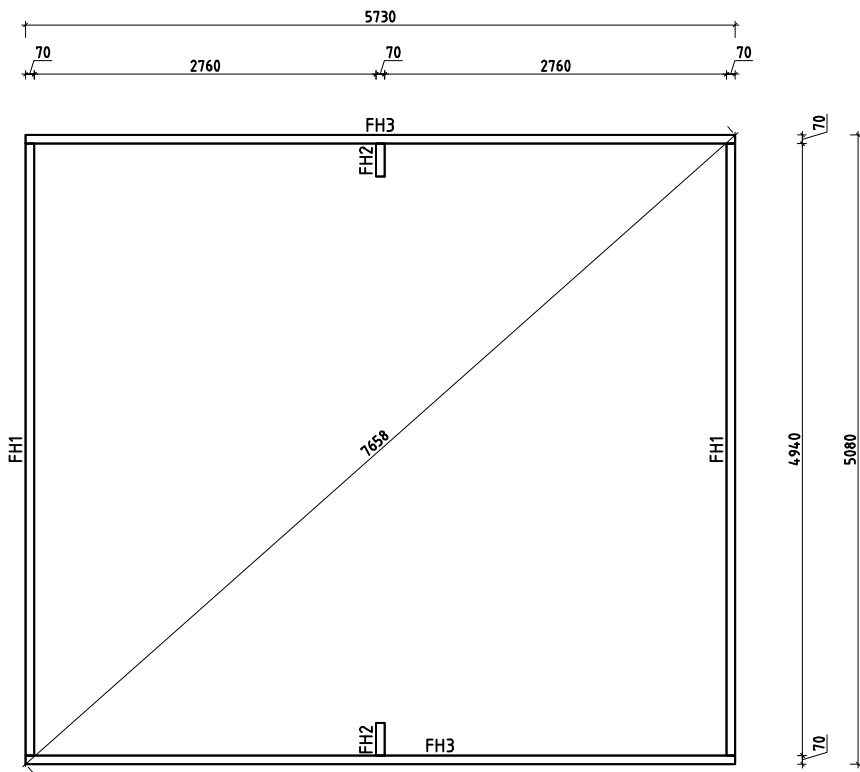



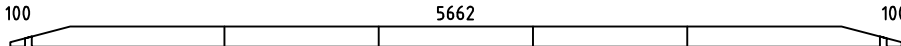
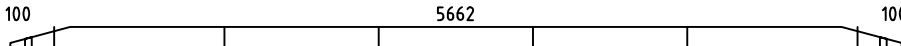
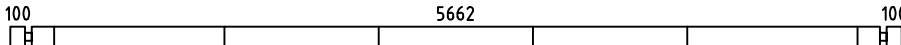
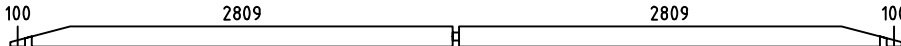
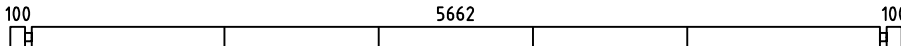
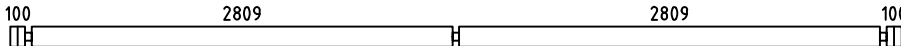
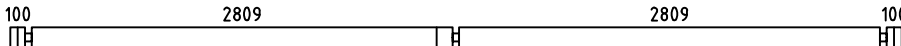

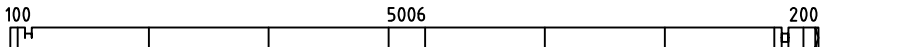
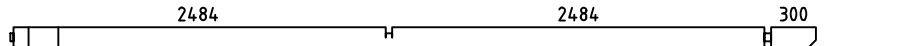
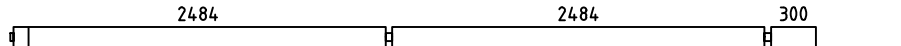
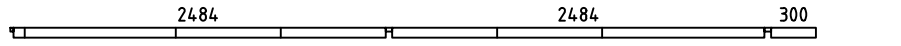
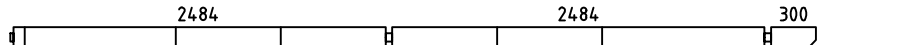
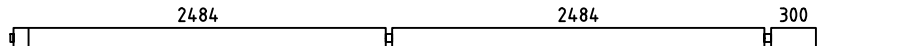
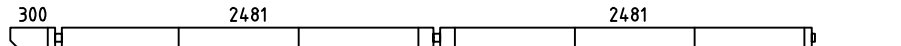
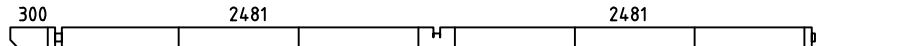
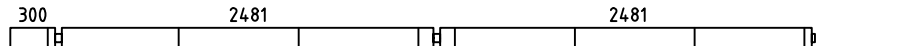

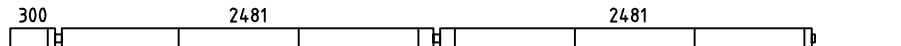
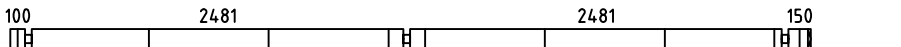
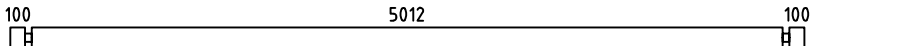
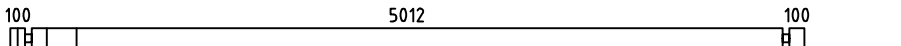
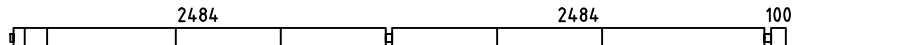
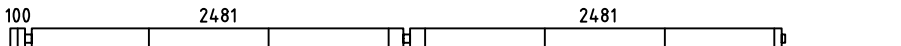
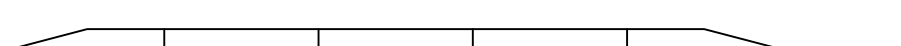

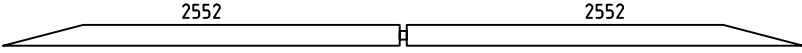
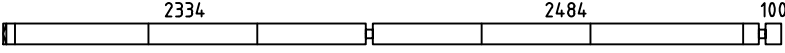
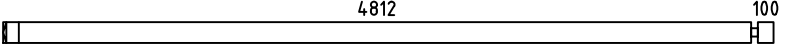
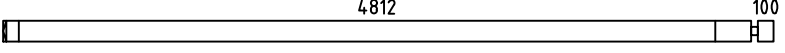
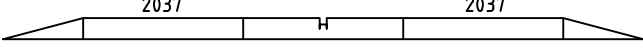
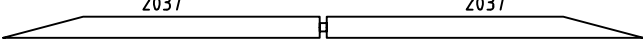
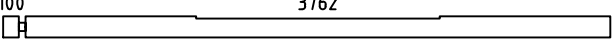
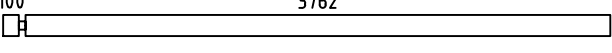
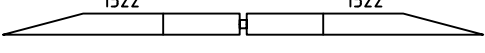
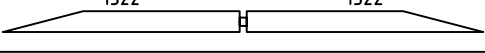
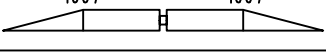
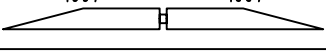
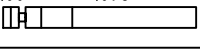
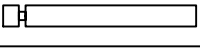
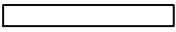
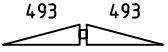
26.05.2023

















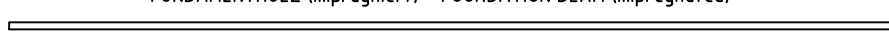
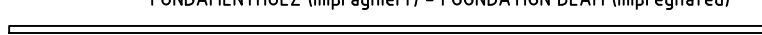

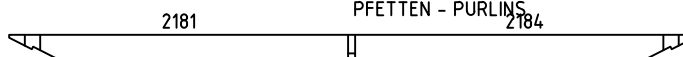
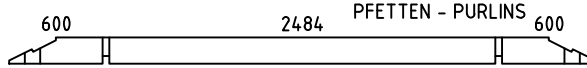
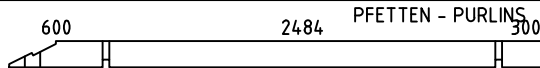
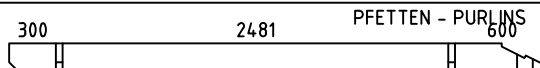
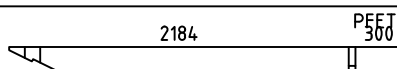
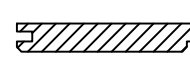





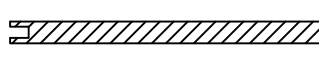













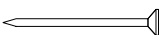
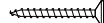
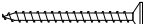
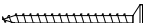
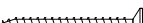





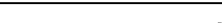
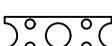

Name	Erkki 595x530; 44	
Zzeichnung/Drawing	Lagerholzplan, Foundation beams	
Profil/Profile	4.4x13.5	Datum/Date 26.05.2023

Pos	Teiteliste/Specification Erkki 595x530; 44	Stck. Pcs.	Profil Profile (mm)	Länge Length (mm)
000	 Extra log	1	44x135	5950
001	 100 5662 100	2	44x135	5950
002	 100 5662 100	1	44x135	5950
003	 100 5662 100	1	44x135	5950
004	 100 2809 2809 100	2	44x135	5950
005	 100 5662 100	2	44x135	5950
006	 100 2809 2809 100	18	44x135	5950
007	 100 2809 2809 100	1	44x135	5950
008	 100 2809 2809 100	1	44x68	5950
009	 100 5006 200	2	44x135	5394
010	 2484 2484 300	2	44x135	5378
011	 2484 2484 300	1	44x135	5378
012	 2484 2484 300	1	44x68	5378
013	 2484 2484 300	1	44x135	5378
014	 2484 2484 300	1	44x135	5378
015	 300 2481 2481	1	44x135	5372
016	 300 2481 2481	2	44x135	5372
017	 300 2481 2481	1	44x135	5372
018	 300 2481 2481	1	44x68	5372
019	 300 2481 2481	1	44x135	5372
020	 100 2481 2481 150	1	44x135	5344
021	 100 5012 100	14	44x135	5300
022	 100 5012 100	1	44x135	5300
023	 2484 2484 100	1	44x135	5178
024	 100 2481 2481	1	44x135	5172
025		3	44x135	5147

Pos	Teiteliste/Specification Erkki 595x530; 44	Stck. Pcs.	Profil Profile (mm)	Länge Length (mm)
026		2	44x135	5147
027		1	44x135	5006
028		1	44x135	4956
029		1	44x135	4956
030		3	44x135	4118
031		2	44x135	4118
032		1	44x135	3906
033		5	44x135	3906
034		3	44x135	3088
035		2	44x135	3088
036		3	44x135	2059
037		2	44x135	2059
038		1	44x135	1242
039		8	44x135	1242
040		9	44x135	1098
041		5	44x129	1029
042		8	44x135	494
043		4	44x135	494
044		3	44x135	494
045		1	44x68	473
046		11	44x135	473
047		4	44x135	473
048		16	44x135	444
049		10	44x135	444
050		10	44x135	444

Pos	Teiteliste/Specification Erkki 595x530; 44	Stck. Pcs.	Profil Profile (mm)	Länge Length (mm)
051	100 300 	2	44x135	444
052	100 300 	1	44x135	444
053	100 300 	1	44x135	444
054	300 100 	2	44x135	444
055	100 215 	2	44x68	359
056	100 215 	30	44x135	359
FH3	FUNDAMENTHOLZ (imprägniert) - FOUNDATION BEAM (impregnated) 	2	70x45	5730
FH1	FUNDAMENTHOLZ (imprägniert) - FOUNDATION BEAM (impregnated) 	2	70x45	4940
FH2	FUNDAMENTHOLZ (imprägniert) - FOUNDATION BEAM (impregnated) 	2	70x45	264
PF1	300 2481 PFETTEN - PURLINS 2181 	3	58x170	5050
PF5	2181 PFETTEN - PURLINS 2184 	3	58x170	4409
PF2	600 2484 PFETTEN - PURLINS 600 	3	58x170	3772
PF6	600 2484 PFETTEN - PURLINS 300 	3	58x170	3472
PF4	300 2481 PFETTEN - PURLINS 600 	3	58x170	3469
PF3	2184 PFETTEN - PURLINS 300 	3	58x170	2528
	DACHBRETTER - ROOF BOARDS 	192+2	113x18	3282
G02-1	GIEBELBRETTER - GABLE BOARDS 18x120 14.7°  ✓	4	18x120	3362
G06-1	GIEBELDECKLEISTEN - GABLE COVER STRIPS 18x58  ✓	4	18x58	3362
T01-1	TRAUFENBRETTER - EAVES BOARDS 18x95 	4	18x95	5375
T06-1	TRAUFENLEISTEN - EAVES STRIPS 18x40  ✓		18x40	22.0 lfm/rm
GS	GIEBELSEGMENT - GABLE DIAMOND 	2		
TP1 20-1	STÜTZPFOSTE - SUPPORT POST 120x120  ✓	2	120x120	2093
HK2	HOLZ-KLOTZEN für verbinden der Wandbohlen - Wooden wedge for connecting the wall parts (122mm) 	3		
SH	SCHLAGHÖLZER - MOUNTING PIECES 	3		
ML1	Metallstange - Metal bar 	2	D10	1040
Kood	Erkki 595x530; 44	Materjal		Leht 3/5

Pos	Teitelist/Specification Erkki 595x530; 44		Stck. Pcs.	Profil Profile (mm)	Länge Length (mm)
ML2	Metallstange - Metal bar		2	D10	970
ML3	Metallstange - Metal bar		6	D10	900
ML4	Metallstange - Metal bar		4	D10	770
ML5	Metallstange - Metal bar		1	D10	560
ML6	Metallstange - Metal bar		4	D10	500
ML7	Metallstange - Metal bar		3	D10	360
MUT26	Mutter - Nut M12 U-Scheibe - Washer Ø30- für die Pfetten - for purlins		48		
KL-1	Gewindestange - Threaded rod M12- für die Pfetten - for purlins		24		170
NG2 550	NÄGEL - NAILS 2.5x50 Dachbretter - Roof boards		1920		
SR3 030	Schrauben - Screws 3.0x30 Traufenleisten - Eaves strips		44		
SR37	Schrauben - Screws 3.5x45 Türleisten - Window/Door strips		50		
SR3 545	Schrauben - Screws 3.5x45 Giebelbretter - Gable boards		28		
SR3 545	Schrauben - Screws 3.5x45 Giebeldeckleisten - Gable cover strips		28		
SR3 545	Schrauben - Screws 3.5x45 Giebelsegment - Gable diamond		4		
SR3 545	Schrauben - Screws 3.5x45 Traufenbretter - Eaves boards		44		
SR354 5-001	Schrauben - Screws 3.5x45 Verbindungsstreifen - Connecting strip		28		
SR44	Schrauben - Screws 4.0x60 Wasserleisten - Rain strips		17		
SR5 0100	Schrauben - Screws 5.0x100 Fundamenthölzer - Foundation beams		24		
SR5 070	Schrauben - Screws 5.0x70 Stützpfoste - Support post		4		
SR507 0-002	Schrauben - Screws 5.0x70 Verstellbare pfostenstütze - Post support		8		
VS	Verbindungsstreifen für verbinden der Wandbohlen - Connecting strip for connecting the wall parts		7		
VP3	Verstellbare Pfostenstütze - Adjustable post support M20		2		
KL1	Gewindestange - Threaded Rod M8		4		2000
KL2	Gewindestange - Threaded Rod M8		6		810
KL3	Gewindestange - Threaded Rod M8		6		540
Kood	Erkki 595x530; 44		Materjal		Leht 4/5

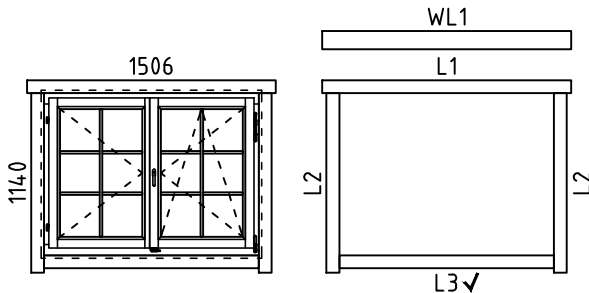
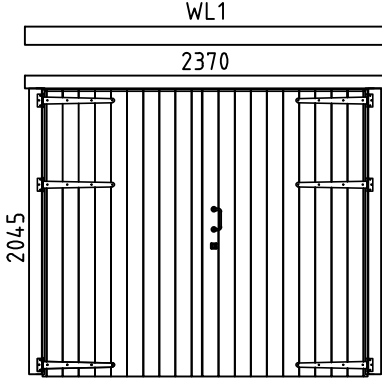
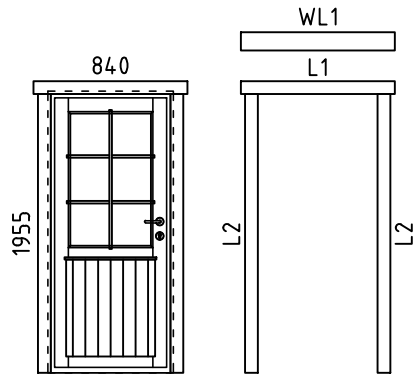
Pos	Teileliste/Specification Erkki 595x530; 44	Stck. Pcs.	Profil Profile (mm)	Länge Length (mm)
KL4	Gewindestange - Threaded Rod M8 	4		528
KL5	Gewindestange - Threaded Rod M8 	11		473
KL6	Gewindestange - Threaded Rod M8 	16		405
KV M UT M8	Mutter - Nut M8 	86		
KV S EIB M8X25	U-Scheibe - Washer M8 Ø25 	86		
KV MU TJ M8	Befestigungsmutter - Fixing nut M8 	4		
	<p>FENSTER/WINDOW 1506x1140 Q4 W4-D44P-06T-15061140</p>  <p>W206-PT</p> <p>L1 18x90 L=1745mm 2x L2 18x90 L=1260mm 4x L3 18x90 L=1505mm 2x ✓ WL1 36x129 L=1745mm 1x</p>	1		
	<p>TÜR/DOOR 2370x2045 D0-V44R-XXX-23702045</p>  <p>DGV-2-RX</p> <p>WL1 36x129 L=2530mm 1x</p>	2		
	<p>TÜR/DOOR 840x1955 Q4 D4-S44L-56T-08401955</p>  <p>D101-LT</p> <p>L1 18x90 L=1080mm 2x L2 18x90 L=1955mm 4x ✓ WL1 36x129 L=1080mm 1x DIN links / left handed</p>	1		
	<b>Achtung!</b> Die Giebelbohlen können teilweise schon vormontiert sein! Bitte beachten - diese erscheinen nicht ganz so wie in der Teileliste beschrieben.			
	<b>Notice!</b> The gable pieces can be partly pre-assembled! Please notice - those differ from the description given in the specification list.			
	✓ - Bitte selber anpassen (falls nötig)! / Cut into length on site (if needed)!			
Kood Erkki 595x530; 44			Materjal	
			Leht 5/5	

1

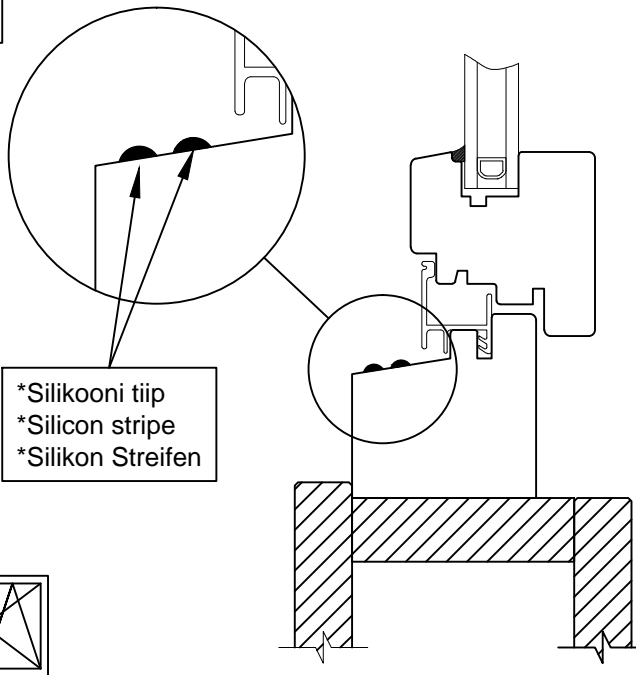

2

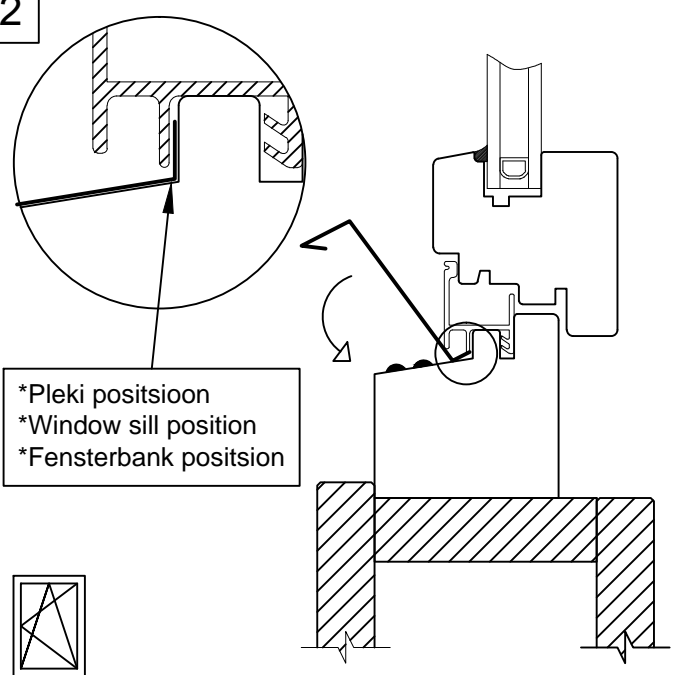

3

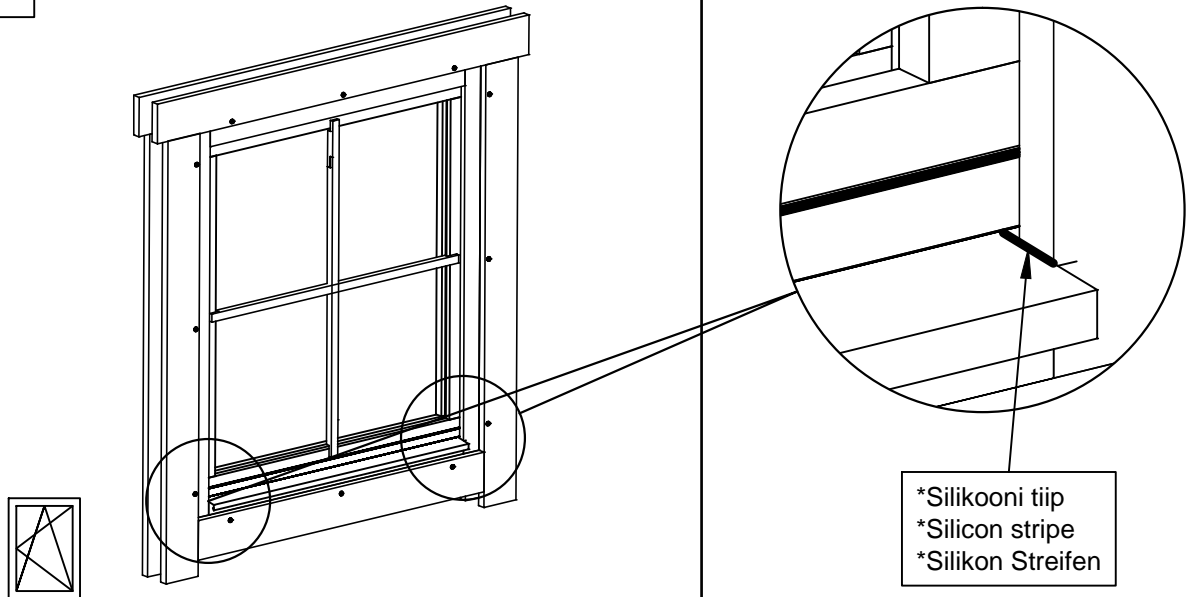

1

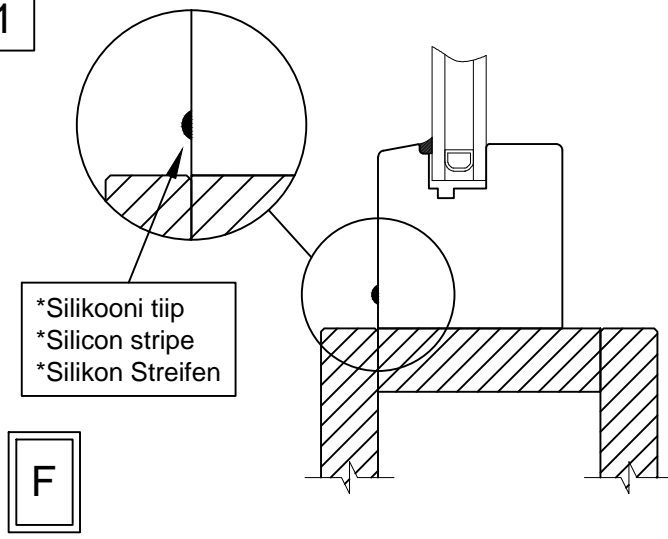

2

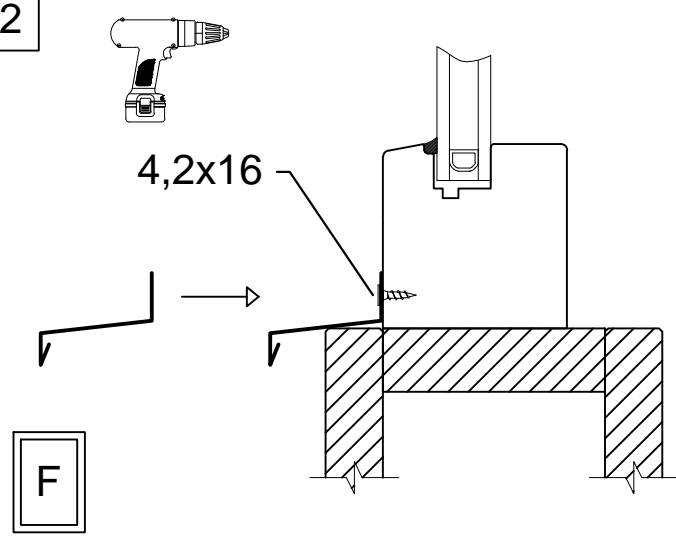

Aken	Q4-Q6	-	paigaldusjuhhis
Window	Q4-Q6	-	assembly instructions
Fenster	Q4-Q6	-	Montageanleitung

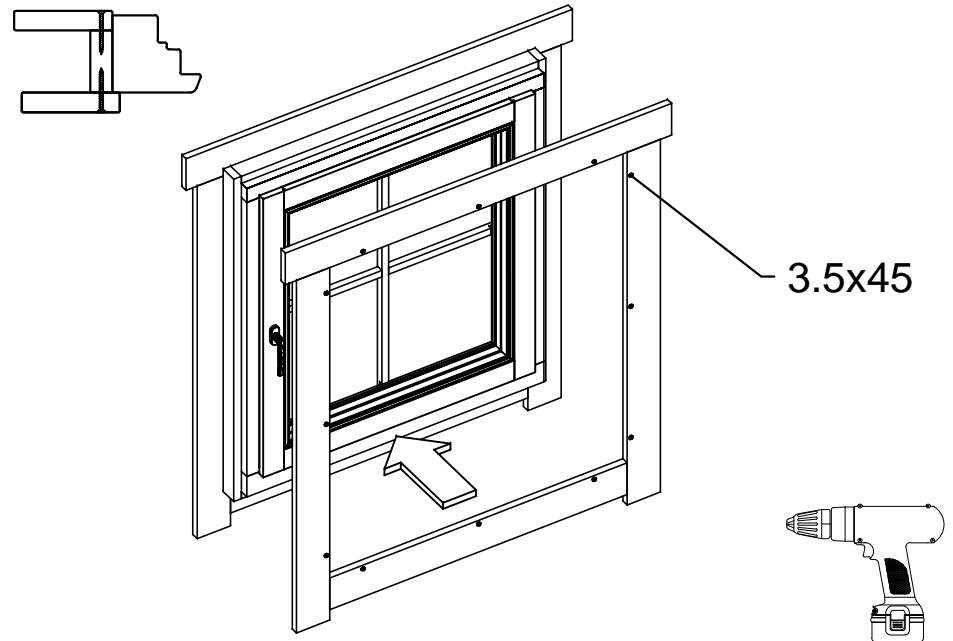
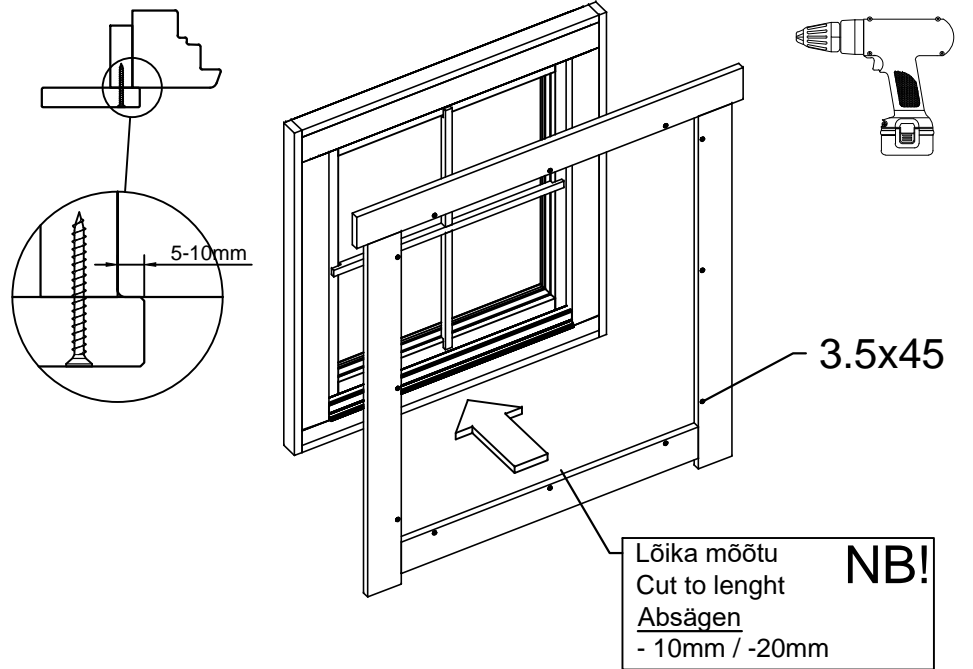
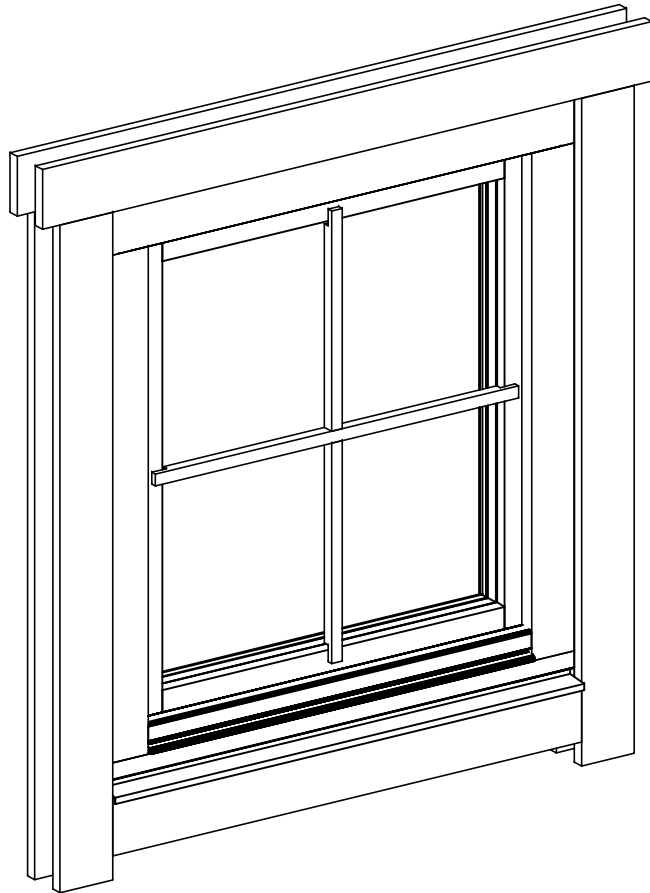

Ukse montaaž / Tür montage / Door assembly  
(GH+ / SH)

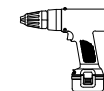
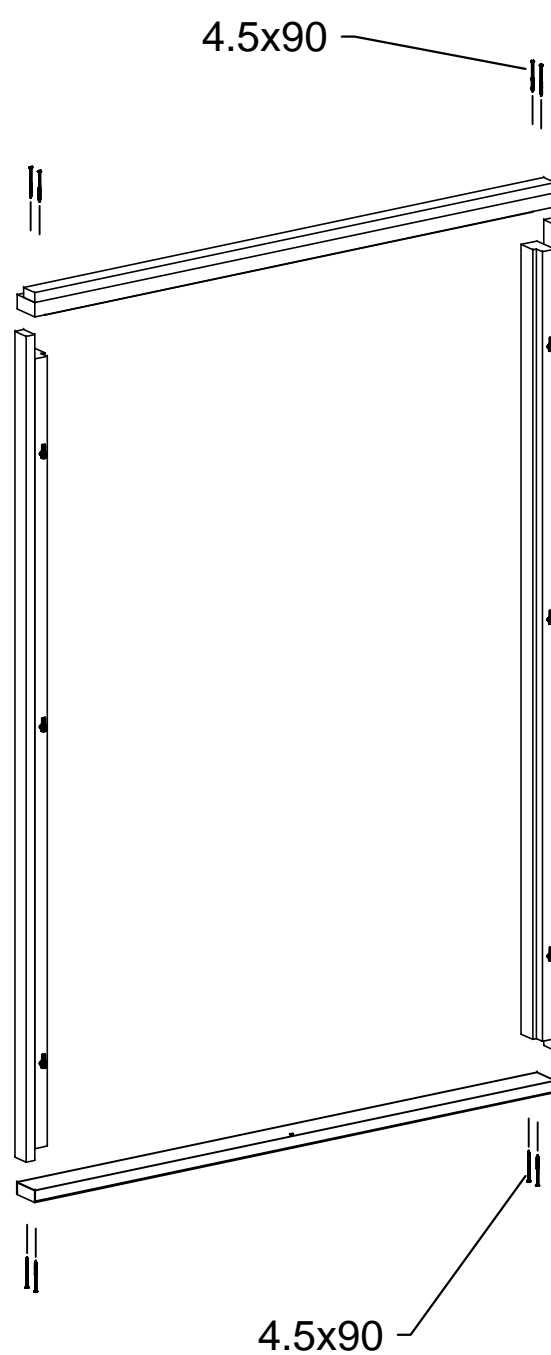
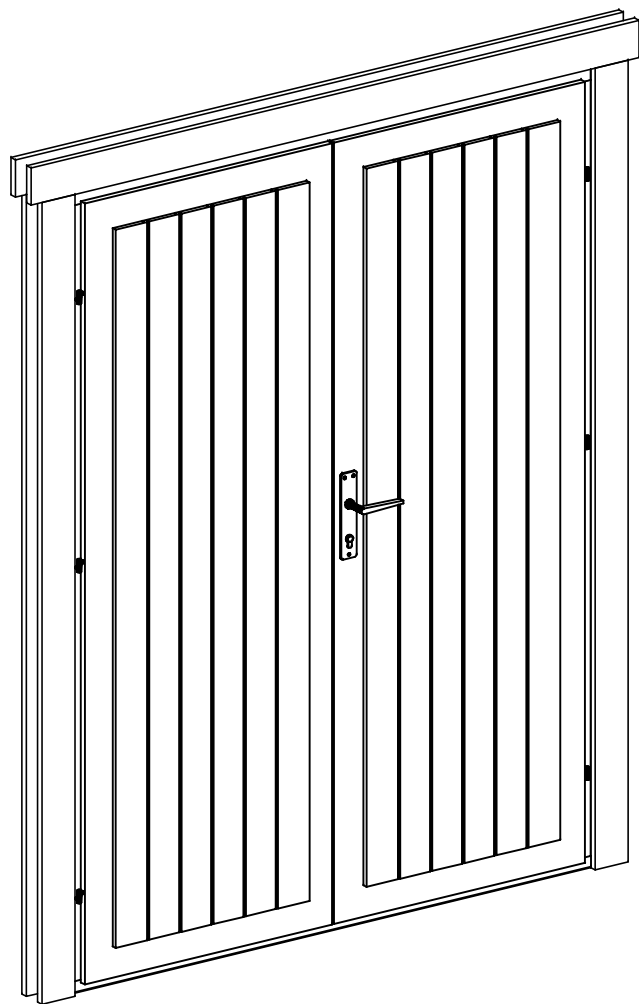

4.5x90

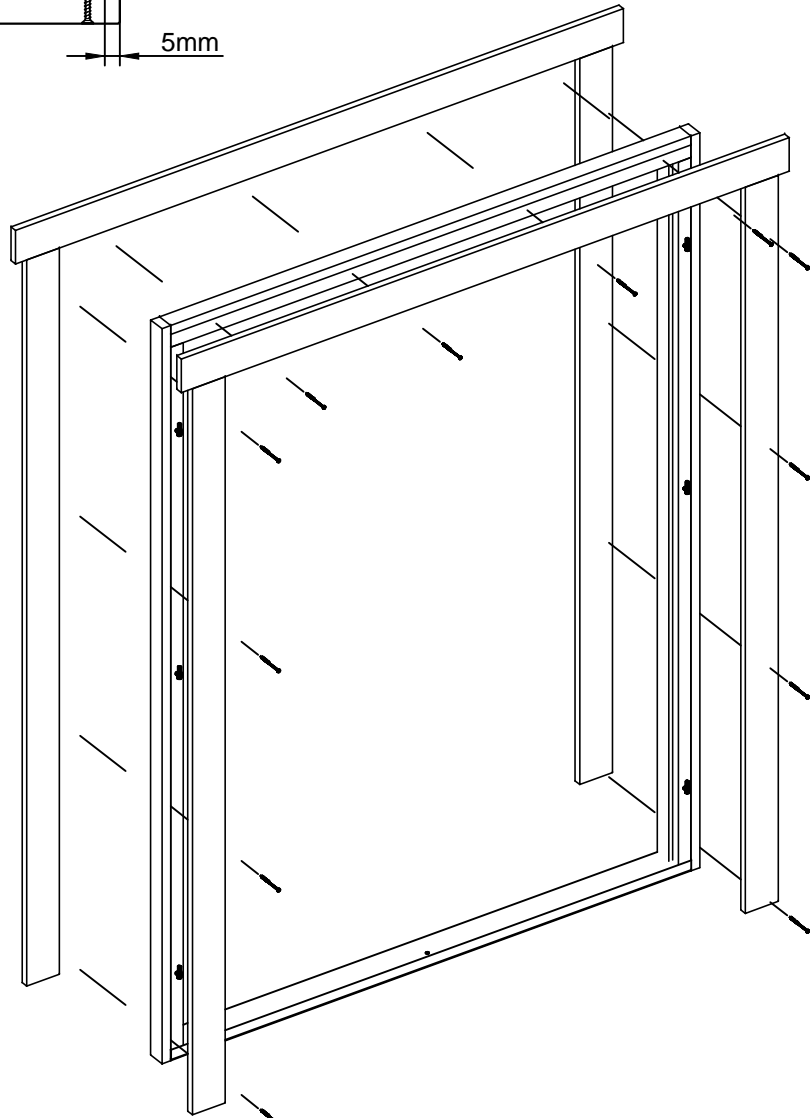
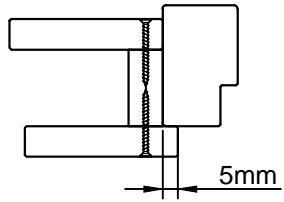

3.5x45

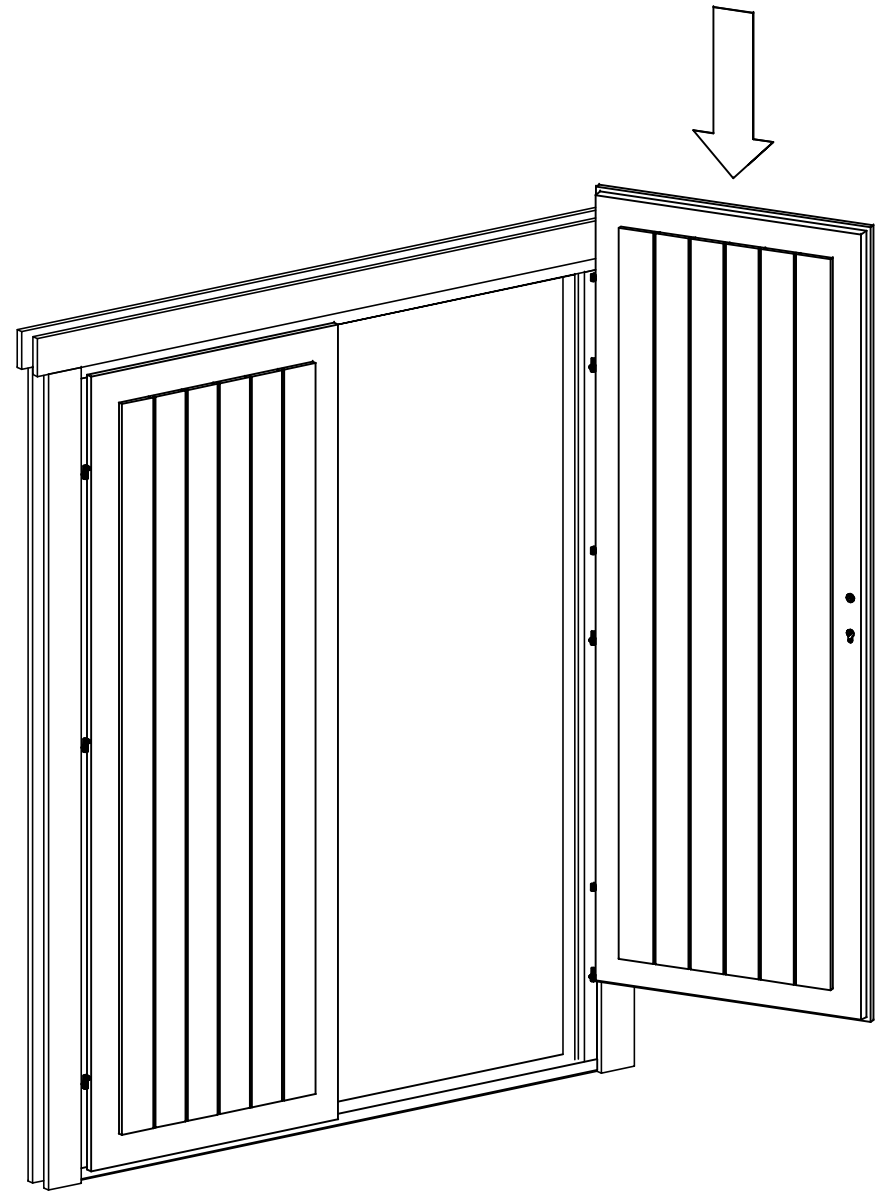

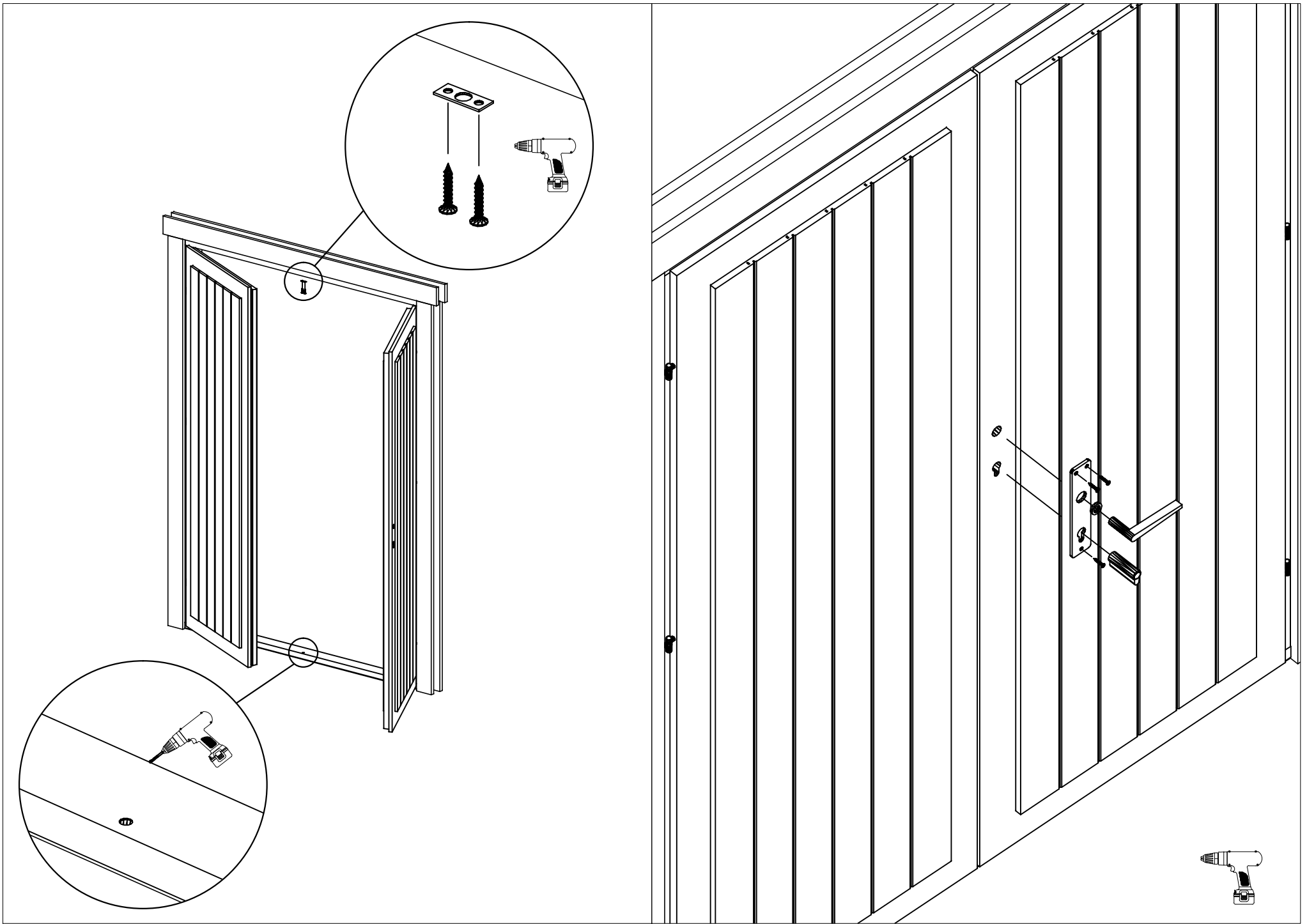

# Vihmaliist / Head flashing / Regenschutz

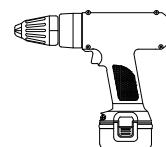
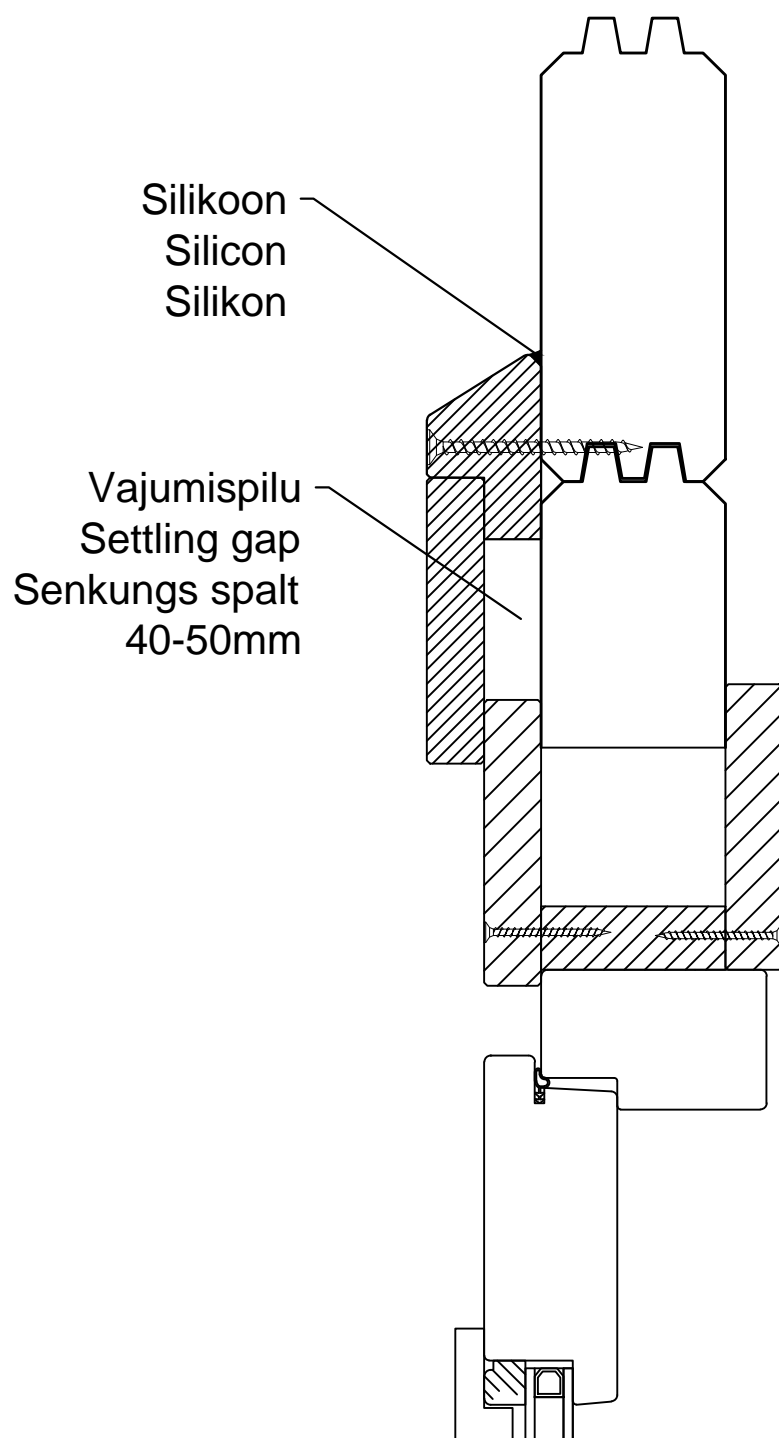

**NB!**

- Monteerida juhul kui ese on välja toodud maja spetsifikatsioonis!
- Install only if the item is listed in the house specification!
- Nur montieren wenn die Leiste in der Teilleiste gezeigt ist!

- Giebeldeckleisten
- Gable cover strips
- Dachbretter
- Roof boards 18x113
- Giebelbretter
- Gable boards
- Pfetten/Wandbohlen
- Purlins/Wall log

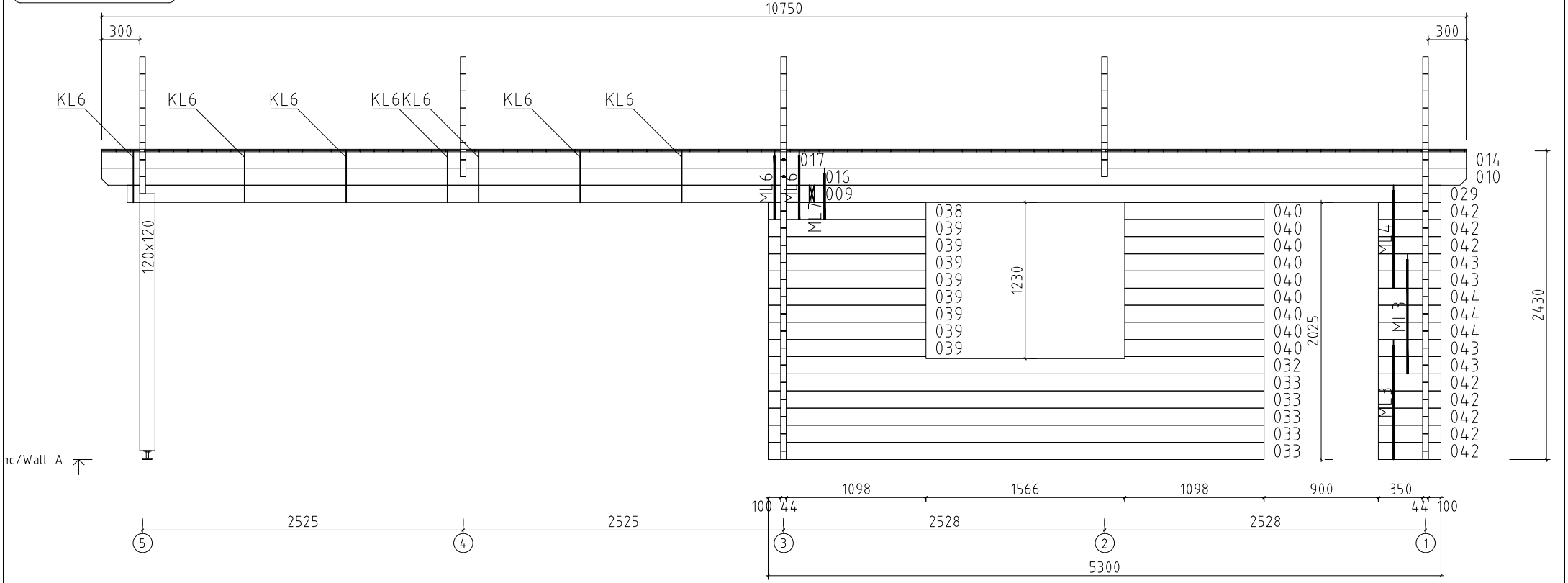

Name	Erkki 595x530; 44		
Zeichnung/Drawing	WAND/WALL A		
Profil/Profile	4.4x13.5	Datum/Date	26.05.2023



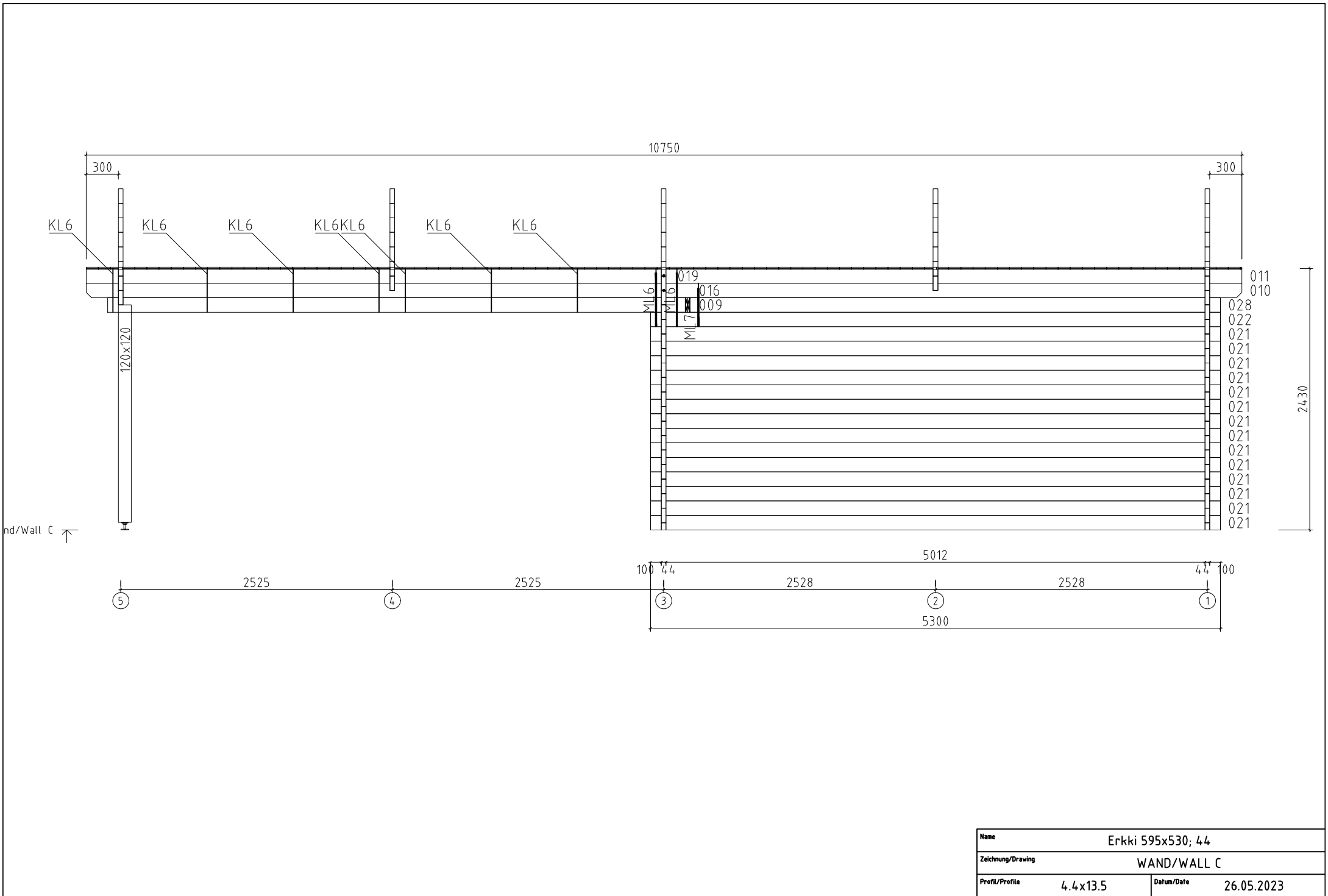



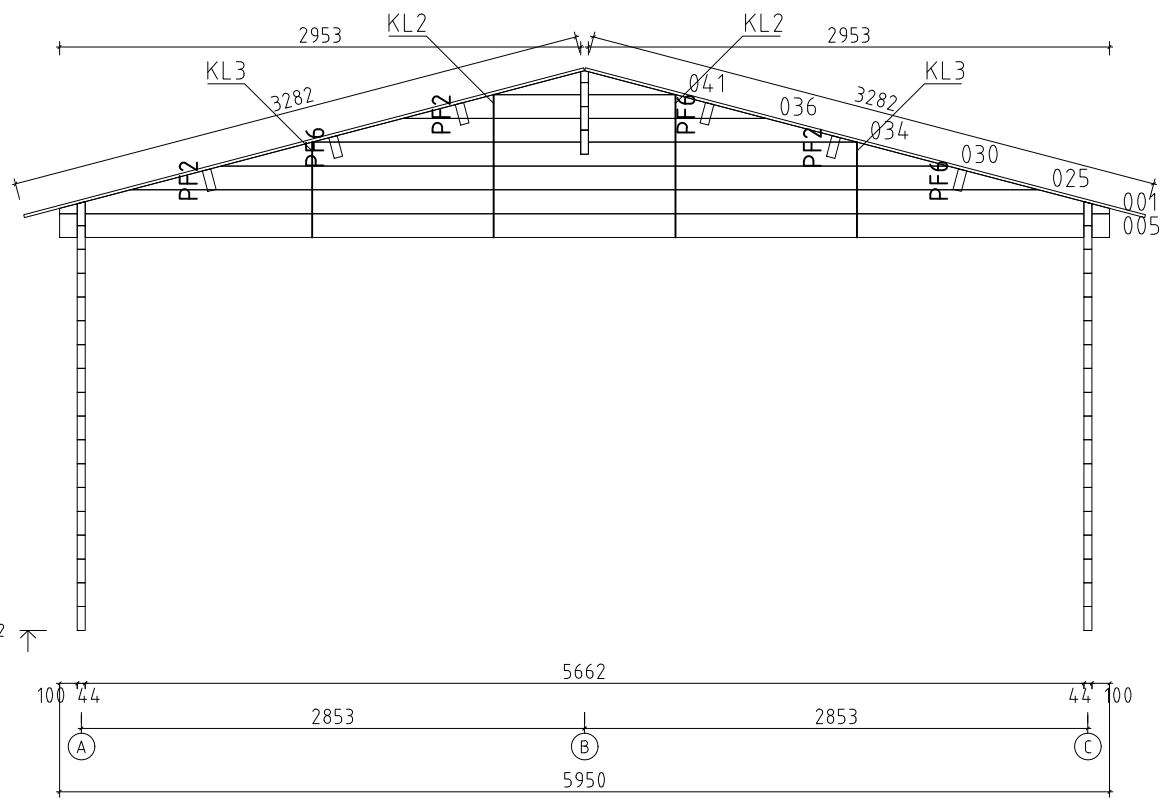

Name	Erkki 595x530; 44		
Zeichnung/Drawing	WAND/WALL C		
Profil/Profile	4.4x13.5	Datum/Date	26.05.2023





Wand/Wall 2 ↗

	Wandbohlen
	Wall logs
	Fundamenthölzer
	Foundation beams

Name	Erkki 595x530; 44		
Zeichnung/Drawing	WAND/WALL 2		
Profil/Profile	4.4x13.5	Datum/Date	26.05.2023

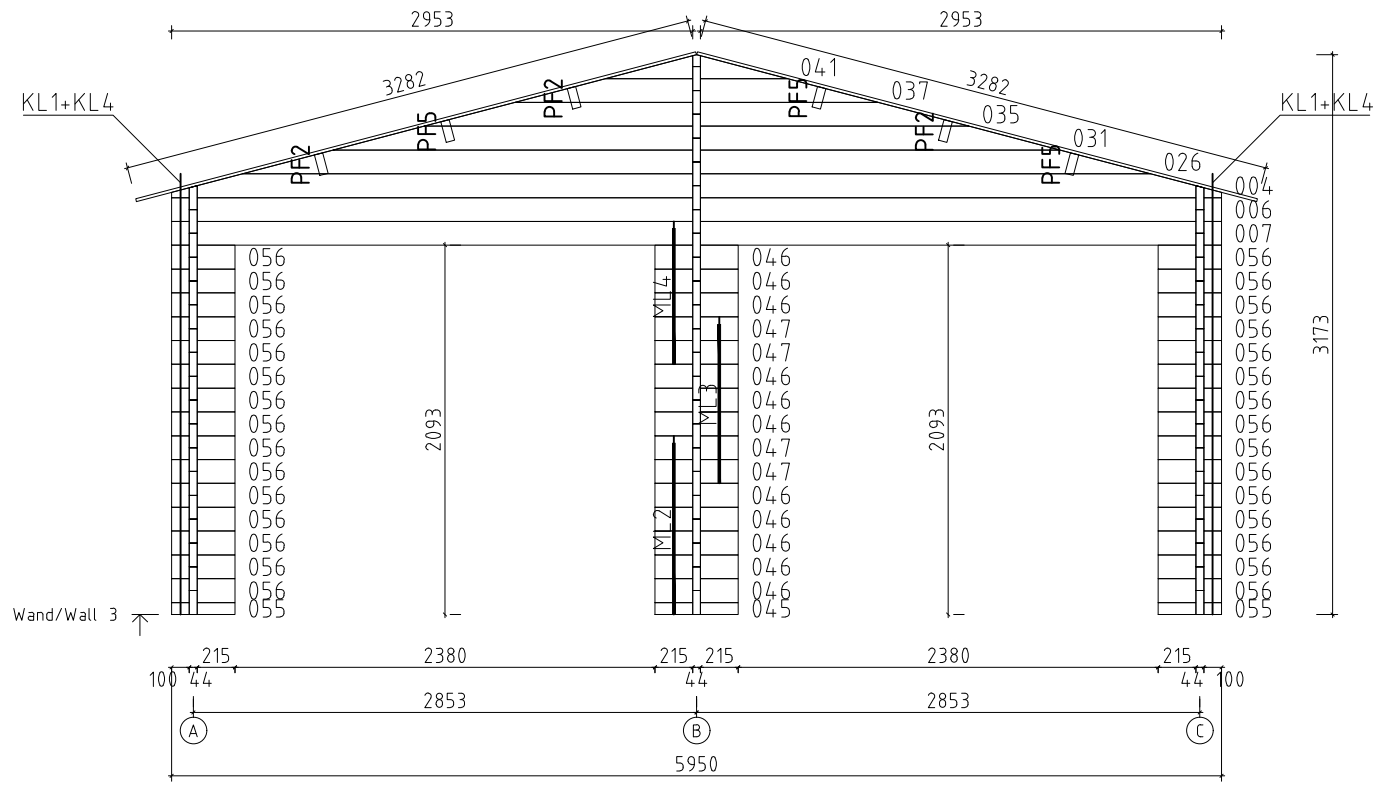

Name	Erkki 595x530; 44		
Zeichnung/Drawing	WAND/WALL 3		
Profil/Profile	4.4x13.5	Datum/Date	26.05.2023

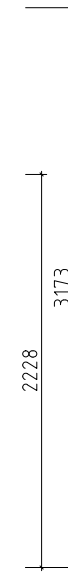
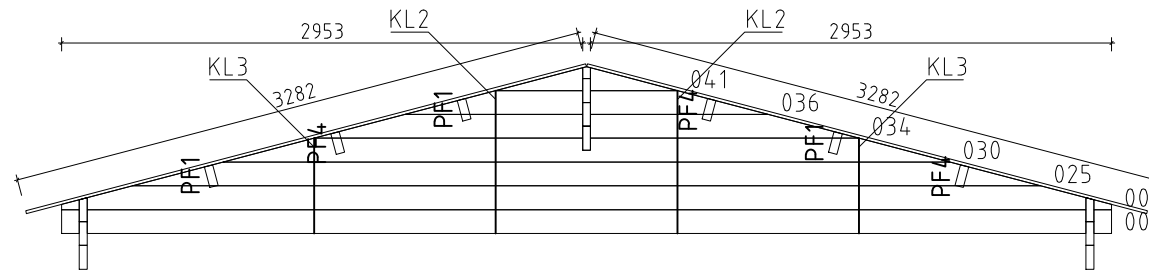

Wand/Wall 4 ↗

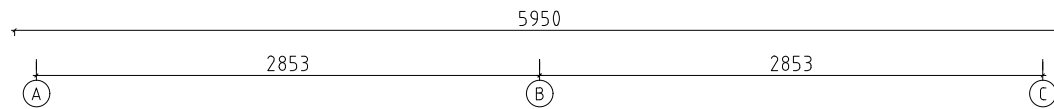

Name	Erkki 595x530; 44		
Zeichnung/Drawing	WAND/WALL 4		
Profil/Profile	4.4x13.5	Datum/Date	26.05.2023

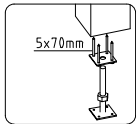
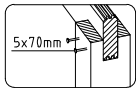
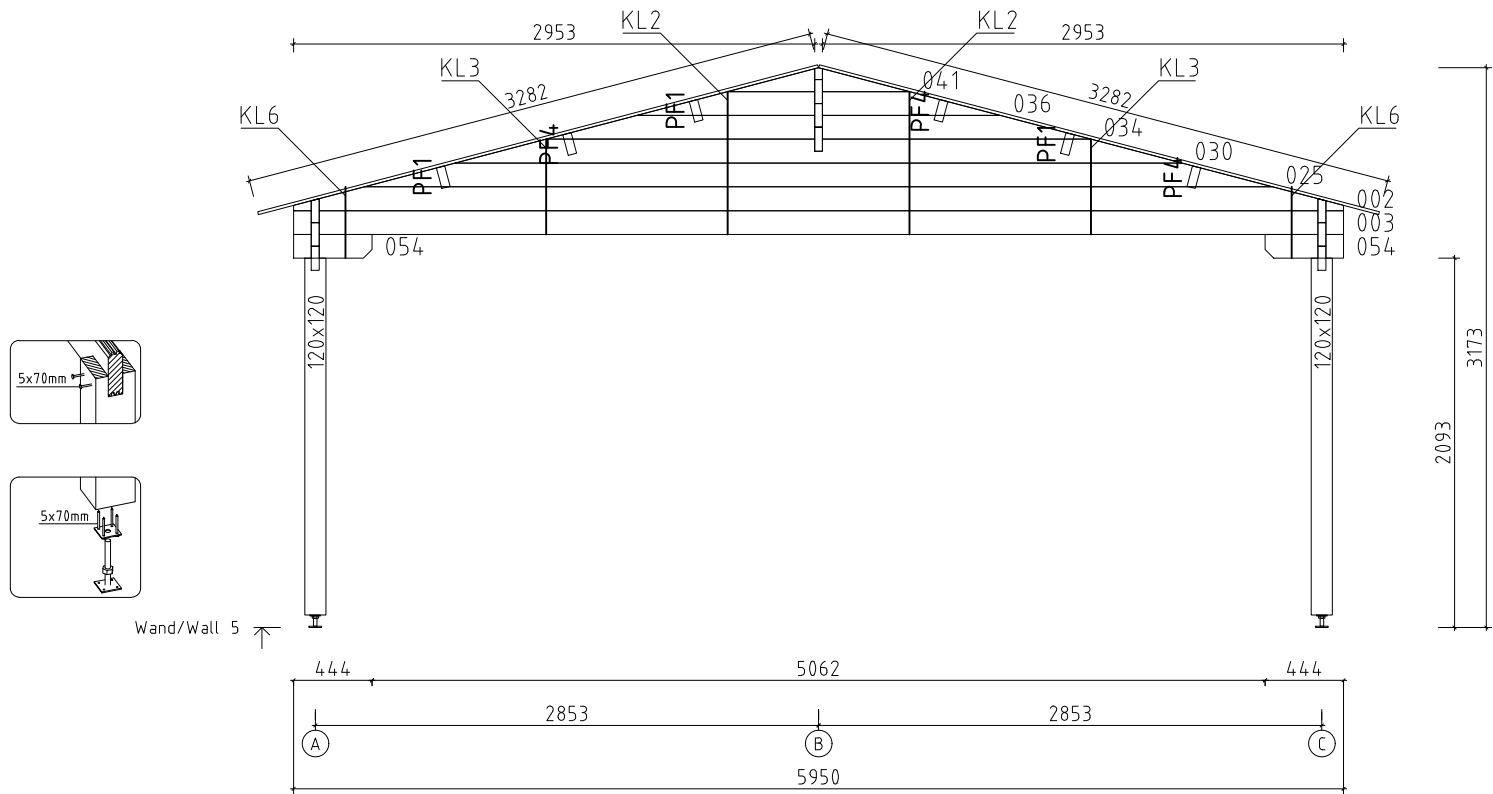

Wand/Wall 5

Name	Erkki 595x530; 44		
Zeichnung/Drawing	WAND/WALL 5		
Profil/Profile	4.4x13.5	Datum/Date	26.05.2023